

LightWire FP200

Compact
Picosecond
Fiber Laser



FEATURES

- ▶ Pulse energy > 50 nJ at repetition rate < 200 kHz
- ▶ 9 ps pulse duration
- ▶ Close to transform limited pulse duration
- ▶ Integrated fiber pulse picker for flexible repetition rate control (20 kHz – 40 MHz, burst mode available)

APPLICATIONS

- ▶ Ultrafast/nonlinear spectroscopy and microscopy
- ▶ Metrology

LightWire FP200 laser is dedicated for researchers and OEM integrators, who require small, convenient and maintenance free source with transform limited picosecond pulses. Widely tunable pulse repetition rate 20 kHz – 40 MHz makes it an excellent

choice for non-linear microscopy, time-resolved spectroscopy, terahertz spectroscopy, ultrafast metrology applications. FP200 model is available with second harmonic option (532 nm).

OPTIONS

- ▶ Second harmonic generation module (532 nm). Peak conversion efficiency: 30% for SH [code: FP200-SH].

PERFORMANCE

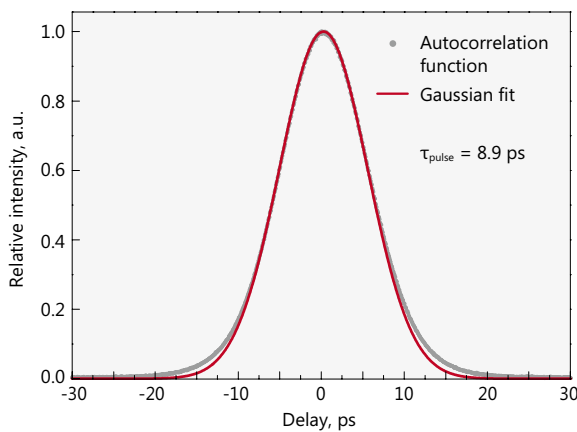

Typical autocorrelation curve of FP200 laser

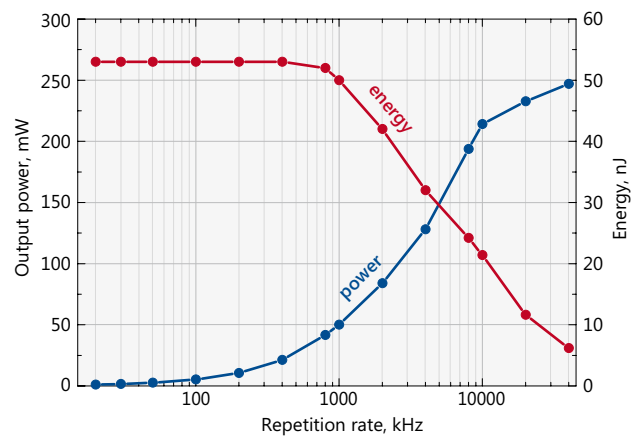

Typical dependence of average power (blue curve) and pulse energy (red curve) on the repetition rate for FP200 laser

SPECIFICATIONS ¹⁾

Model	FP200
Central wavelength	1064 nm, tunable ± 0.2 nm
Pulse duration	9 ± 1 ps
Spectral bandwidth	0.25 ± 0.05 nm
Oscillator pulse repetition rate	40 ± 2 MHz
Pulse repetition rate range using frequency divider	20 kHz – 40 MHz ($PRR = PRR_{osc} / N$, $N = 1, 4, 5, \dots, 2000$)
Output power	> 200 mW at 10 MHz > 40 mW at 1 MHz > 5 mW at 100 kHz
Pulse energy	> 50 nJ at repetition rates < 200 kHz
Polarization	linear, vertical, > 100:1 extinction
Optical output	collimator & isolator node ²⁾ (free space output)
Umbilical	3 m length armored cable $\varnothing 5$ mm
Beam diameter	0.9 ± 0.1 mm
Beam height	50 mm
Beam quality	$M^2 < 1.1$
Pulse train monitoring	photodiode output for oscillator train, TTL synch pulse for laser output
Dimensions of control unit (L x W x H)	315 x 450 x 95 (stand alone) or 315 x 482 x 95 (19" rack mountable)
Dimensions of collimator & isolator node (L x W x H)	164 x 72 x 73 mm
Weight (with/without pulse picker)	< 10 kg
Control interface	USB, CAN, RS232, LAN, WLAN
Power supply (AC/DC adapter included)	100–240 V, 50–60 Hz AC
Power consumption	maximal 230 W (typical 60 W)
Operating conditions	10–30 °C, humidity – not condensing



¹⁾ Due to continuous improvement all specifications are subject to change without notice.

²⁾ FP200 model is provided with specially designed collimator & isolator node, which shouldn't be disconnected from output fiber without Ekspla approval.

DRAWINGS

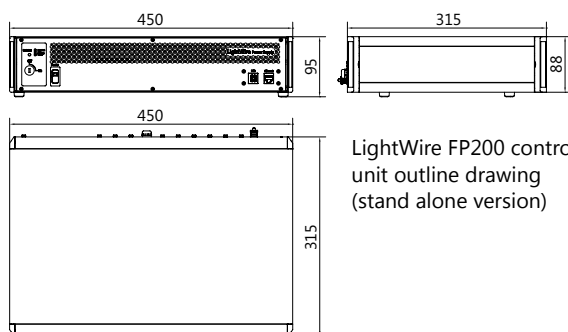

LightWire FP200 control unit outline drawing (stand alone version)

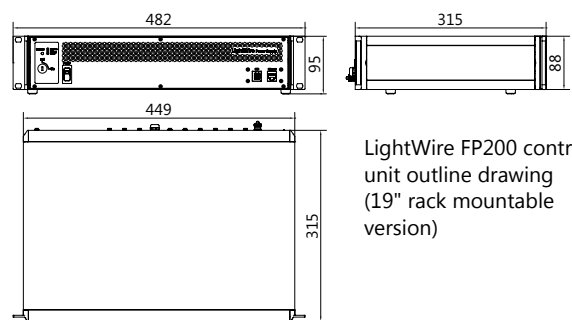

LightWire FP200 control unit outline drawing (19" rack mountable version)

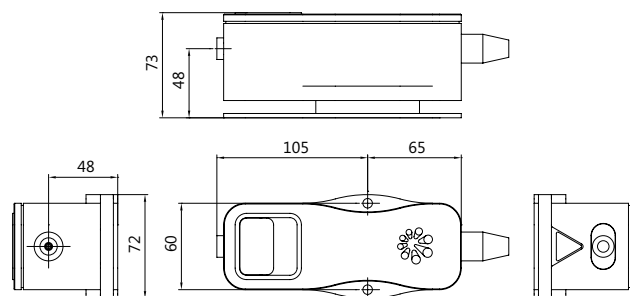

LightWire FP200 laser isolator & collimator unit outline drawing

All dimensions are in millimetres.