

# Atlantic



## Industrial High Power Picosecond Lasers

### MATERIALS

- ▶ Various metals
- ▶ Brittle materials including glass, ceramics, sapphire and PCD
- ▶ Silicon
- ▶ PET, PP, PI, PTFE
- ▶ Silicone
- ▶ PCB
- ▶ LCD, LED, OLED, microLED display panels
- ▶ Solar cells

High-energy and high-power water-cooled Atlantic series picosecond lasers are designed for a variety of industrial applications such as LCD or OLED display cutting and drilling, laser induced forward transfer (LIFT), glass and sapphire processing, micromachining of ultra-hard materials, ablation of metals, cutting and drilling of polymers, silicon scribing, solar cell scribing and many more. Superior beam quality parameters, maximum available average power (80W@IR / 40W@VIS / 30W@UV), maximum available pulse energy (200µJ@IR / 100µJ@VIS / 75µJ@UV) and maximum pulse repetition rate (up to 1MHz) are beneficial where high processing quality and high throughput are required.

To tailor laser performance for specific industrial applications, advanced electronics enable external gating (including PSO), synchronization and precise laser triggering as well as instant signal amplitude control.

To maintain reliability and assure long-term stable operation in an industrial environment, optical components are installed in a sealed, robust, precisely machined monolithic aluminum block. Designed for robust, low maintenance operation, Atlantic series lasers offer maximum reliability due to an optimized layout, PC controlled operation, a built-in self-diagnostic system and advanced status reporting.

### FEATURES

- ▶ Up to **80 W** at **1064 nm**
- ▶ Optional **532 nm** and **355 nm** wavelengths (could be all 3 electronically switchable wavelengths)
- ▶ Up to **1 MHz** repetition rate
- ▶ Up to **200 µJ** pulse energy
- ▶ Short pulse duration **10 ps**
- ▶ Excellent beam quality  $M^2 < 1.3$
- ▶ Versatile laser control and synchronisation capabilities
- ▶ Smart triggering for synchronous operation with polygon scanner and PSO
- ▶ Monolithic, sealed and rugged design
- ▶ Low life-time ownership cost
- ▶ Nanosecond pulse duration mode (optional)

### APPLICATIONS

- ▶ Drilling
- ▶ Cutting
- ▶ Patterning
- ▶ Structuring
- ▶ Ablation
- ▶ Dicing
- ▶ Micromachining
- ▶ LCD, OLED cutting
- ▶ Laser induced forward transfer
- ▶ Sapphire structuring and dicing
- ▶ Ceramics micromachining
- ▶ PCD drilling and tracing
- ▶ Silicon scribing
- ▶ PET, PP, PTFE, Silicone cutting and drilling

For industrial high-power UV laser applications, high reliability and low ownership cost of UV components is crucial. To meet these requirements, the optical layouts of Atlantic UV models are optimized for longevity and stable operation in the UV range, resulting in a UV optics lifetime of 8,000 hours.

A unique optional feature of Atlantic high-power lasers is that they can work in both picosecond and nanosecond modes. This 2-in-1 laser solution is beneficial for some materials processing (such as glass or ceramics), where both very high accuracy, low processed surface roughness and high throughput are required at low cost.

**TYPICAL VIEW OF ATLANTIC SERIES LASER HEADS**



Typical view of Atlantic 6HE, 25, 50, 80 laser head with a single 1064 nm output



Typical view of Atlantic 6HE, 25, 50, 80 laser head with two and three outputs



Typical view of Atlantic 6HE-UV2HE, 25-UV8, 50-UV18, 80-UV30 laser head with a single 355 nm output

**SPECIFICATIONS <sup>1)</sup>**

Model	Atlantic 6HE	Atlantic 25	Atlantic 50	Atlantic 80
<b>GENERAL SPECIFICATIONS</b>				
Central wavelength				
Fundamental	1064 nm			
With second harmonics option	532 nm (optional 1064 nm output) <sup>2)</sup>			
With third harmonics option	355 nm (optional 1064 nm and/or 532 nm outputs) <sup>2)</sup>			
Laser pulse repetition rate (PRR <sub>L</sub> ) range <sup>3)</sup>	30 kHz	200 – 1000 kHz	300 – 1000 kHz	400 – 1000 kHz
Pulse repetition rate after frequency divider	PRR = PRR <sub>L</sub> / N, N=1, 2, 3, ... , 1025			
Maximal average output power <sup>4)</sup>				
at 1064 nm	6 W	25 W	50 W	80 W
at 532 nm	3 W	12 W	25 W	40 W
at 355 nm	2 W	8 W	18 W	30 W
Pulse energy at lowest PRR <sub>L</sub> <sup>4)</sup>				
at 1064 nm	200 µJ	125 µJ	165 µJ	200 µJ
at 532 nm	100 µJ	60 µJ	85 µJ	100 µJ
at 355 nm	75 µJ	40 µJ	60 µJ	75 µJ
Pulse contrast				
at 1064 nm	> 300 : 1			
at 532 nm	> 500 : 1			
at 355 nm	> 1000 : 1			
Power long term stability over 8 h after warm-up (Std. dev.) <sup>5)</sup>	< 1.0 %			
Pulse energy stability (Std. dev.) <sup>6)</sup>				
at 1064 nm	< 1.0 %			
at 532 nm	< 2.0 %			
at 355 nm	< 2.5 %			
Pulse duration (FWHM) at 1064 nm	10 ± 3 ps			
Polarization	linear, vertical 100 : 1			
M <sup>2</sup>	< 1.3			
Beam circularity, far field	> 0.85			
Beam divergence, full angle	< 1.5 mRad			
Beam pointing stability (pk-to-pk) <sup>7)</sup>	< 50 µRad			
Beam diameter (1/e <sup>2</sup> ) at 50 cm distance from laser aperture				
at 1064 nm	1.8 ± 0.3 mm			
at 532 nm	2.2 ± 0.3 mm		1.8 ± 0.3 mm	2.2 ± 0.3 mm
at 355 nm	2.0 ± 0.3 mm		1.8 ± 0.3 mm	2.0 ± 0.3 mm
Triggering mode	internal / external			
Pulse output control	frequency divider, pulse picker, instant amplitude control, power attenuation			
Control interfaces	keypad / USB / RS232 / LAN			
<b>OPERATING REQUIREMENTS</b>				
Mains requirements	100...240 V AC, single phase 47...63 Hz			
Maximal power consumption	< 2.8 kW	< 2.8 kW	< 3.1 kW	< 3.5 kW
Operating ambient temperature	18–27 °C			
Relative humidity	10–80 % (non-condensing)			
Air contamination level	ISO 9 (room air) or better			

Model	Atlantic 6HE	Atlantic 25	Atlantic 50	Atlantic 80
<b>PHYSICAL CHARACTERISTICS</b>				
Cooling	water			
Laser head size (W × H × L)				
single output 1064 nm	396 × 173 × 755 mm			
single output 355 nm	396 × 173 × 1000 mm			
3 outputs 1064 / 532 / 355 nm	396 × 173 × 926 mm			
Power supply unit size (W × H × L)	553 × 1019 × 852 mm			
Umbilical length	4 m			
<b>CLASSIFICATION</b>				
Classification according EN60825-1	CLASS 4 laser product			

- <sup>1)</sup> Due to continuous improvement, all specifications are subject to change without notice. Parameters marked typical are not specifications. They are indications of typical performance and will vary with each unit we manufacture.
- <sup>2)</sup> Can be ordered either in a single output or in 2 or 3 separate harmonics outputs versions.
- <sup>3)</sup> When frequency divider is set to transmit every pulse.
- <sup>4)</sup> See typical power and energy curves for other pulse repetition rates.
- <sup>5)</sup> At the lowest PRR, after warm-up under constant environmental conditions.
- <sup>6)</sup> At the lowest PRR, under constant environmental conditions.
- <sup>7)</sup> Beam pointing stability is evaluated as a movement of the beam centroid in the focal plane of a focusing element.



PERFORMANCE

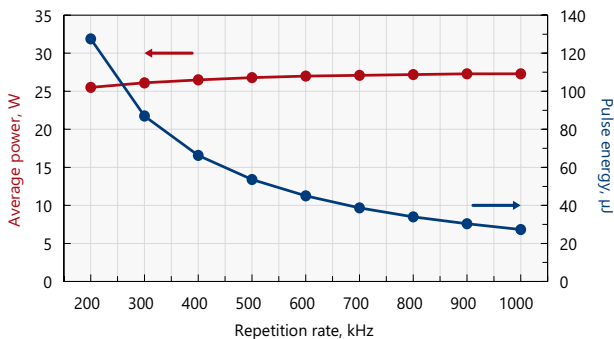

Typical output power and energy curves of Atlantic 25

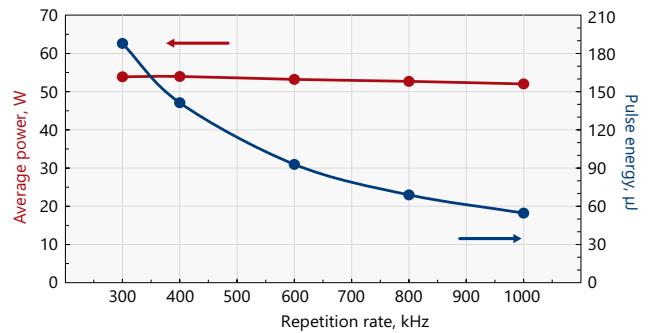

Typical output power and energy curves of Atlantic 50

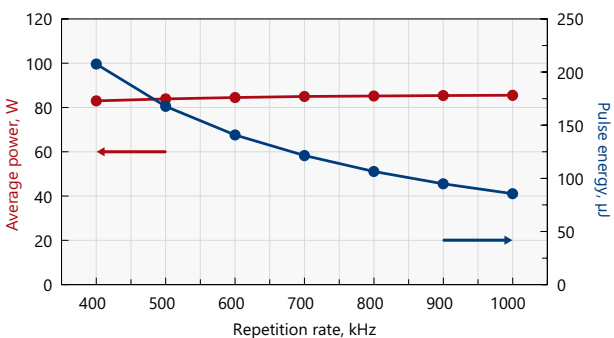

Typical output power and energy curves of Atlantic 80

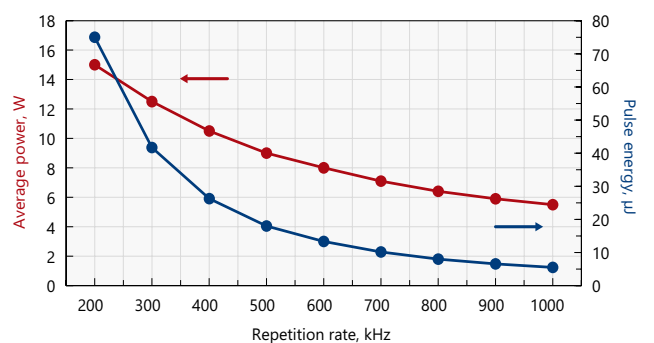

Typical output power and energy curves of Atlantic 25-GR12

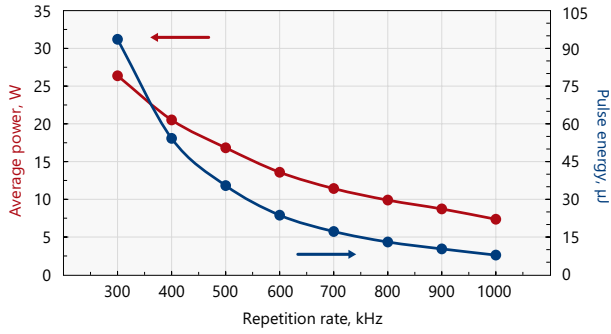

Typical output power and energy curves of Atlantic 50-GR25

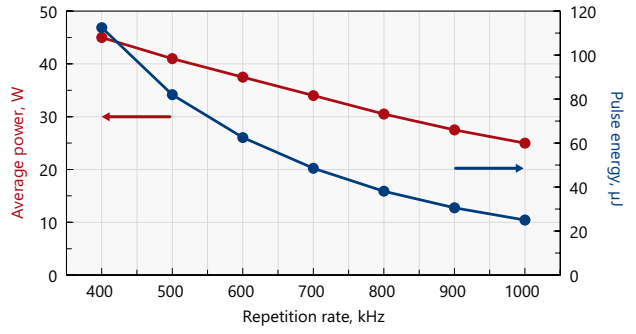

Typical output power and energy curves of Atlantic 80-GR40

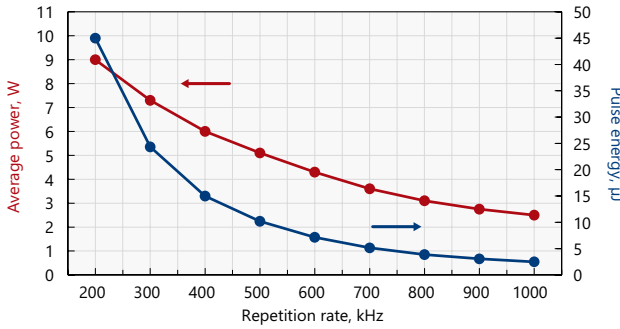

Typical output power and energy curves of Atlantic 25-UV8

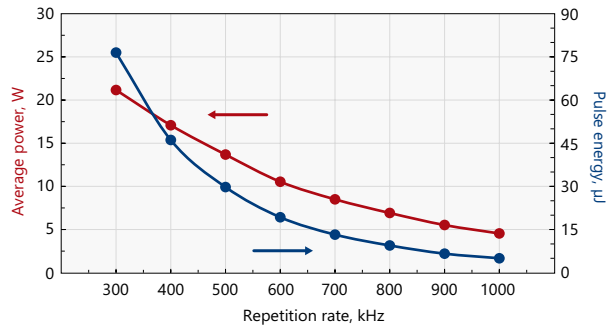

Typical output power and energy curves of Atlantic 50-UV18

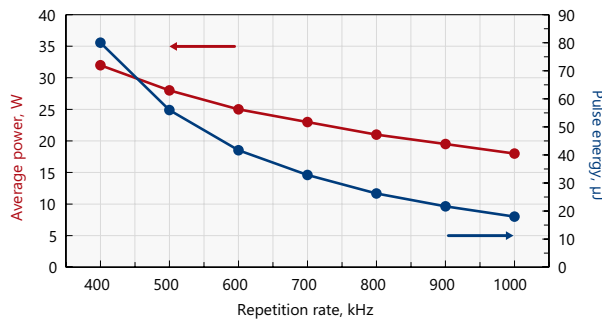

Typical output power and energy curves of Atlantic 80-UV30

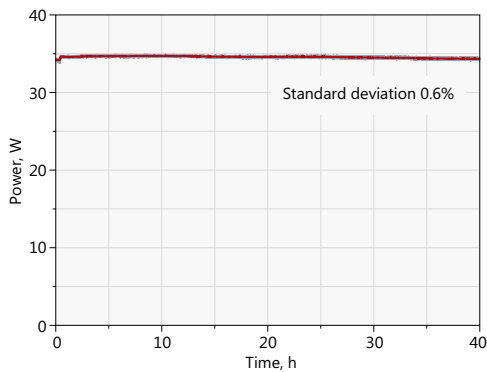

Typical long term 355 nm output average power stability of Atlantic 80-UV30 under constant environmental conditions

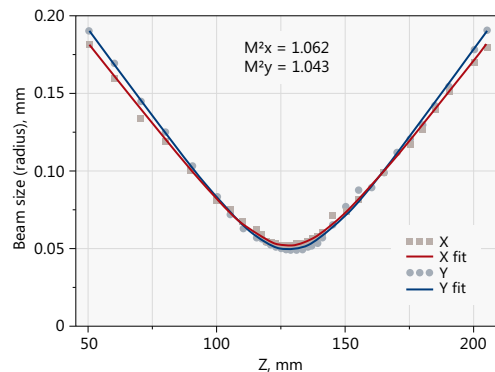

Typical  $M^2$  measurement of 355 nm wavelength at 34 W average power, 400 kHz repetition rate (Atlantic 80-UV30)

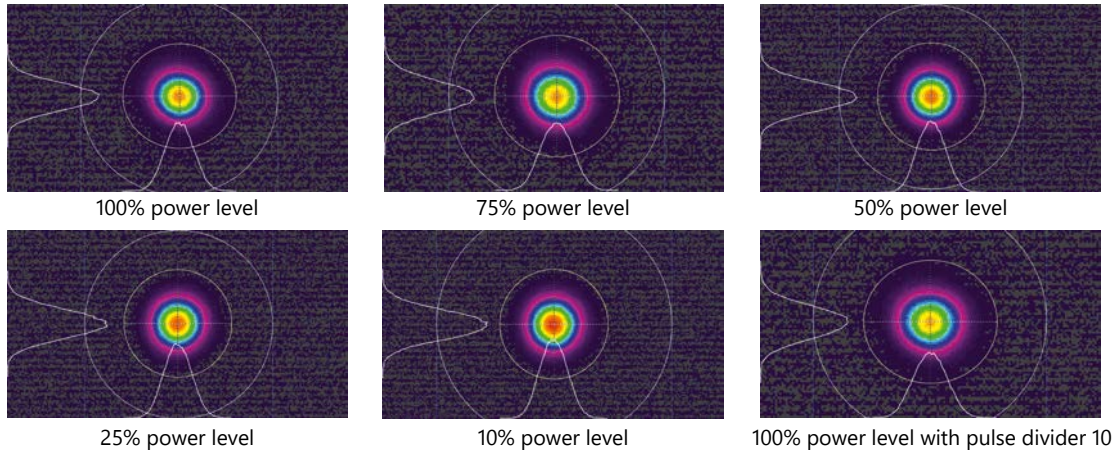

Typical beam profile of 355 nm in far field at 34 W max average power with different attenuation conditions

ORDERING INFORMATION

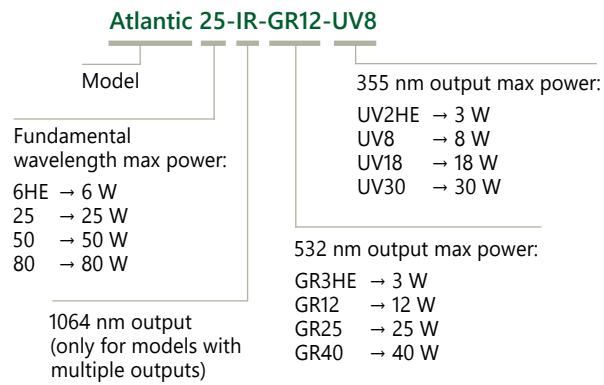

LASER HEAD & POWER SUPPLY OUTLINE DRAWINGS

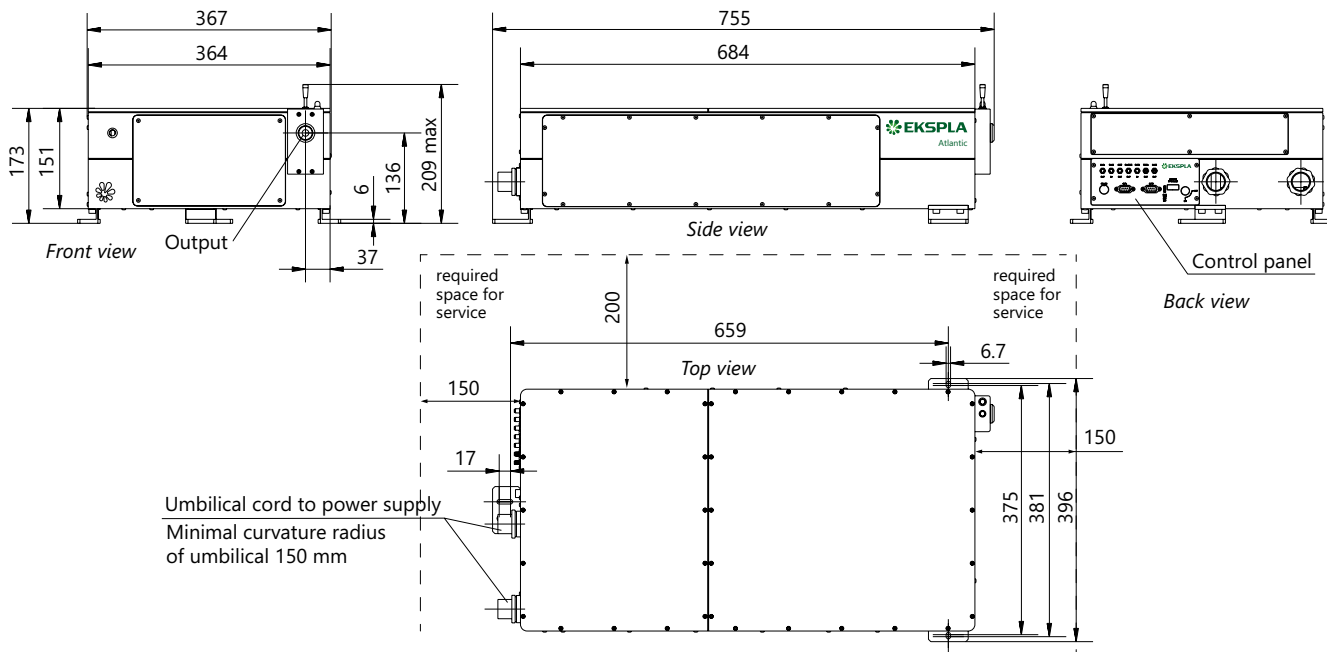

Outline drawings of Atlantic 6HE, 25, 50, 80 laser head with a single 1064 nm output (dimensions in mm)

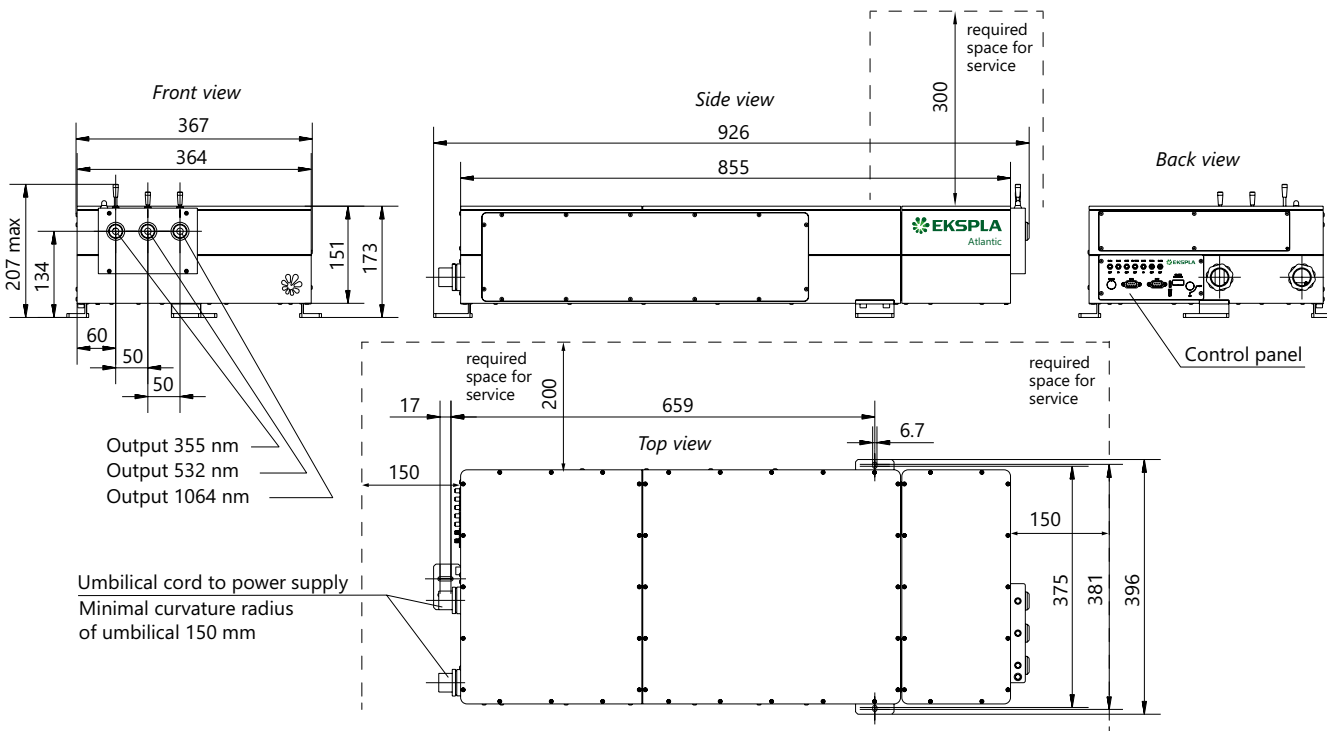

Outline drawings of Atlantic 6HE, 25, 50, 80 laser head with two and three outputs (dimensions in mm)

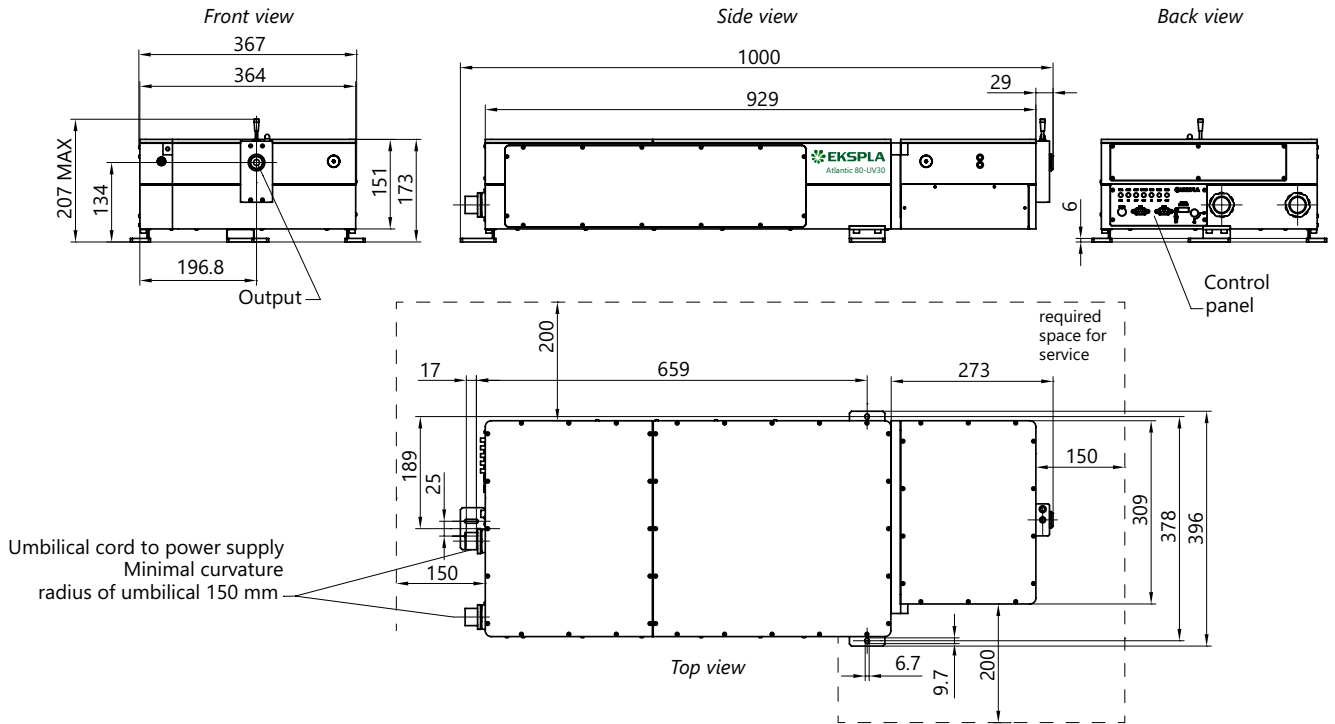

Outline drawings of Atlantic 6HE-UV2HE, 25-UV8, 50-UV18, 80-UV30 laser head with a single 355 nm output (dimensions in mm)

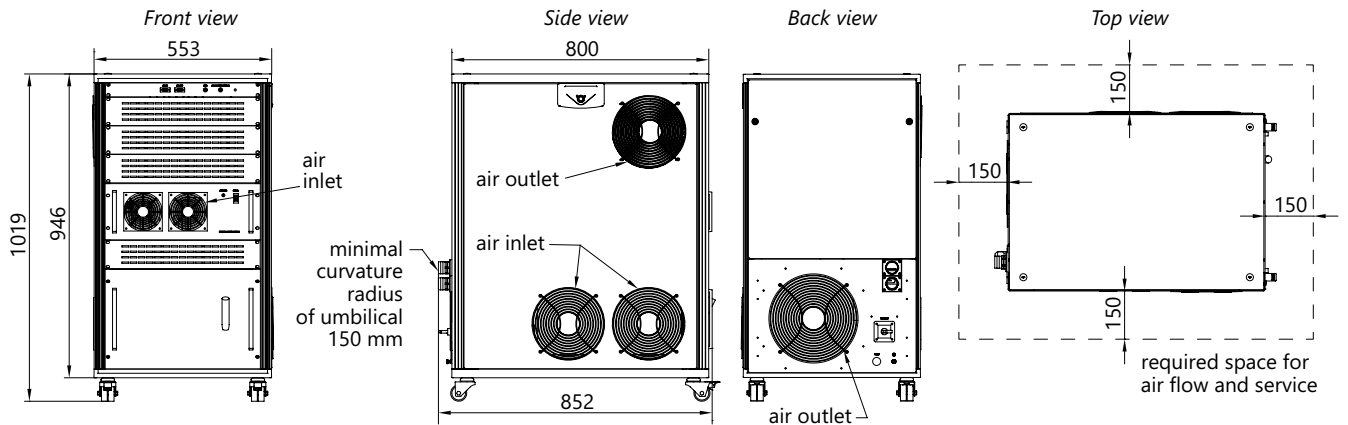

Outline drawings of Atlantic 6HE, 25, 50, 80 power supply unit (dimensions in mm)