

fs

Industrial
Femtosecond
Lasers

FemtoLux 3

Applications

- / Inner volume marking of transparent materials
- / Marking and structuring
- / Micromachining of brittle materials
 - / Photopolymerization
- / Ophthalmologic surgery
 - / Biological Imaging
- / Pumping of femtosecond OPO/OPA
 - / Microscopy



Microjoule Class Femtosecond Industrial Lasers

FemtoLux 3

FemtoLux 3 is a modern femtosecond fiber laser aimed for both R&D use and industrial integration.

Tunable pulse duration in a range of 300 fs – 5 ps, adjustable pulse repetition rate up to 10 MHz and adjustable pulse energy up to 3 μ J allows optimization of laser parameters for the desired application. These include marking and volume structuring of transparent materials, photopolymerization, biological imaging, nonlinear microscopy and many others. To expand the scope of applications even further this laser can be equipped with a second harmonics module.

With burst mode enabled, FemtoLux 3 can generate bursts of pulses with energy above 10 μ J with instant burst shape control which can significantly improve the efficiency of processes.

Having a rigid, compact, passive air-cooled laser head and the possibility to control the laser from a wireless tablet, FemtoLux 3 can be integrated with different equipment, be it laser equipment for material micro-processing, microscopy or any other research equipment.



FemtoLux 3 laser with second harmonic option

Features

Output power
3 W at 1030 nm,
1.2 W at 515 nm

Up to **3 μ J/pulse** and
10 μ J/burst (at 1030 nm)

Up to **1.2 μ J/pulse** and
5 μ J/burst (at 515 nm)

< **300 fs ... 5 ps**
tunable pulse duration

$M^2 < 1.2$

Versatile laser control and
synchronisation capabilities

Up to **10 MHz**
pulse repetition rate

Smart triggering for
synchronous operation with
polygon scanner and PSO

Instant amplitude control

Passive air cooling of the laser
head

24/7 operation

At 1030 nm

At 515 nm

Output power

3 W

1.2 W

Pulse energy

3 μ J

1.2 μ J

Burst mode

10 μ J

5 μ J



Learn more
about FemtoLux 3
www.ekspla.com

Specifications ¹⁾

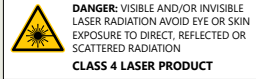
Model		FemtoLux 3
Main specifications		
Central wavelength	fundamental	1030 nm
	with second harmonic option	515 nm
Minimal pulse duration (FWHM) at 1030 nm		< 300 fs (typical ~230 fs)
Pulse duration tuning range		300 fs – 5 ps
Maximal average output power ²⁾	at 1030 nm	> 3 W
	at 515 nm	> 1.2 W
Power long term stability (Std. dev.) ³⁾		≤ 0.5 %
Maximal pulse energy ²⁾	at 1030 nm	> 3 μJ
	at 515 nm	> 1.2 μJ
Pulse energy stability (Std. dev.) ⁴⁾		< 2 %
Laser pulse repetition rate (PRR _i) range ⁵⁾		1 – 10 MHz
Pulse repetition rate after pulse picker		PRR = PRR _i / N, N=1, 2, 3, ... , min 10 kHz
External pulse gating		via TTL input
Burst mode ⁶⁾		1 – 10 pulses
Max burst energy	at 1030 nm	> 10 μJ
	at 515 nm	> 5 μJ
Burst shape control		via analog input
Power attenuation		0 – 100 % from remote control application or via analog input
Polarization orientation		linear, vertical
Polarization extinction ratio		> 1000:1
M ²		< 1.2
Beam divergence (full angle)		< 1.0 mrad
Beam circularity (far field)		> 0.85
Beam pointing stability (pk-to-pk) ⁷⁾		< 30 μrad
Beam diameter (1/e ²) at 20 cm distance from laser aperture	at 1030 nm	2.0 ± 0.3 mm
	at 515 nm	1.0 ± 0.2 mm
Operating requirements		
Mains requirements		100–240 V AC, single phase 47–63 Hz
Maximal power consumption		< 500 W
Operating ambient temperature		15 – 30 °C
Relative humidity		10 – 80 % (non-condensing)
Air contamination level		ISO 9 (room air) or better
Physical characteristics		
Cooling of the laser head		air, passive
Laser head size (L×W×H)	at 1030 nm	464 × 363 × 129 mm
	at 515 nm	620 × 363 × 129 mm
Power supply unit size (L×W×H)	stand-alone	449 × 436 × 140 mm
	19" rack mountable	483 × 436 × 140 mm
Umbilical length		5 m
Classification		
Classification according EN60825-1		CLASS 4 laser product
<div style="display: flex; justify-content: space-between;"> <div style="width: 30%;"> <p>¹⁾ Due to continuous improvement, all specifications are subject to change without notice. Parameters marked typical are not specifications. They are indications of typical performance and will vary with each unit we manufacture.</p> <p>²⁾ See typical power and energy curves for other pulse repetition rates at Fig 1, Fig 2. and Fig 4.</p> <p>³⁾ At 1 MHz PRR_i during 24 h of operation after warm-up under constant environmental conditions.</p> </div> <div style="width: 30%;"> <p>⁴⁾ At 1 MHz PRR_i under constant environmental conditions.</p> <p>⁵⁾ When pulse picker is set to transmit every pulse.</p> <p>⁶⁾ Pulse separation inside the burst is about 20 ns.</p> <p>⁷⁾ Beam pointing stability is evaluated as a movement of the beam centroid in the focal plane of a focusing element.</p> </div> <div style="width: 30%; text-align: right;">  </div> </div>		

Performance

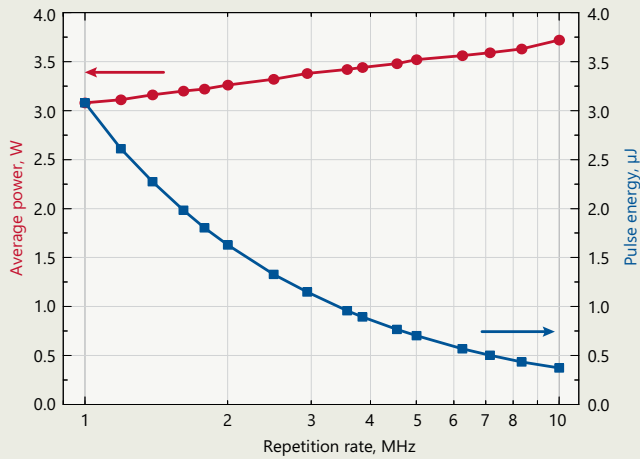

Fig 1. Typical dependence of output power and pulse energy of FemtoLux 3 laser at 1030 nm when changing internal repetition rate of the laser

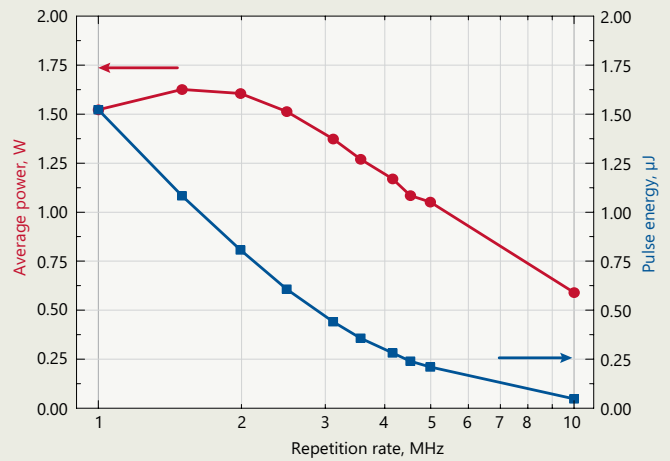

Fig 2. Typical dependence of output power and pulse energy of FemtoLux 3 laser at 515 nm on pulse repetition rate

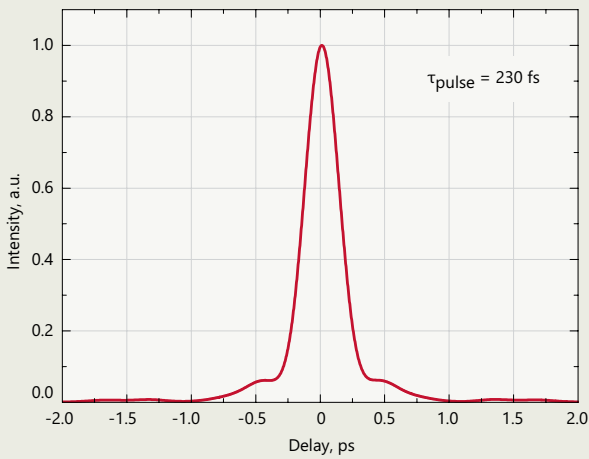

Fig 3. Typical FemtoLux 3 laser (at 1030 nm) output pulse autocorrelation function at 3 μJ pulse energy. Calculated pulse duration is 230 fs

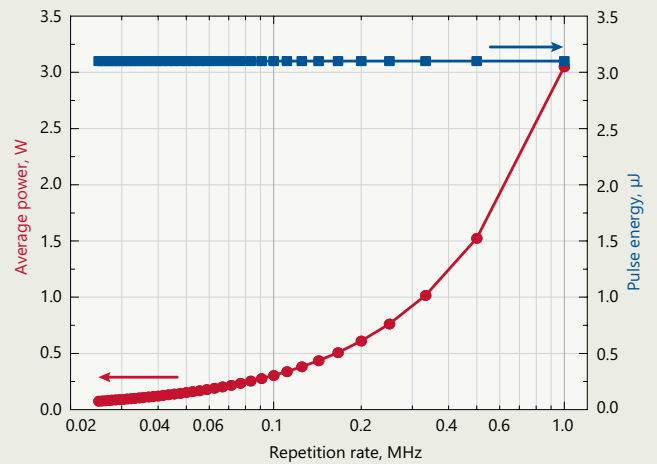

Fig 4. Typical dependence of output power and pulse energy of FemtoLux 3 laser at 1030 nm when repetition rate is reduced by pulse picker. Internal repetition rate of the laser in this case is 1 MHz

Stability

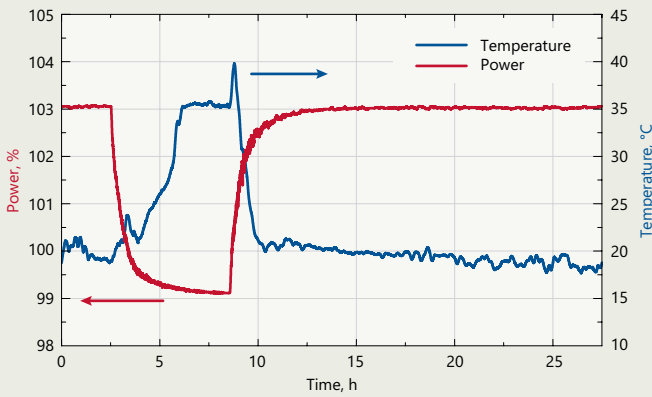

Fig 5. Average output power dependence on ambient temperature at 1030 nm

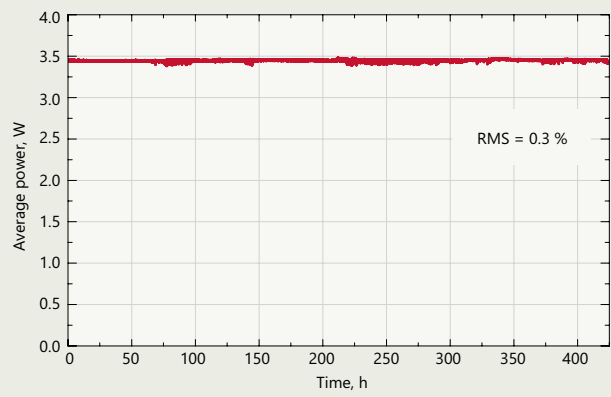

Fig 6. Typical long term average output power stability of FemtoLux 3 laser at 1030 nm under constant environmental conditions

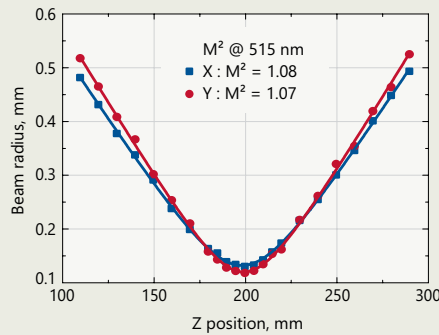
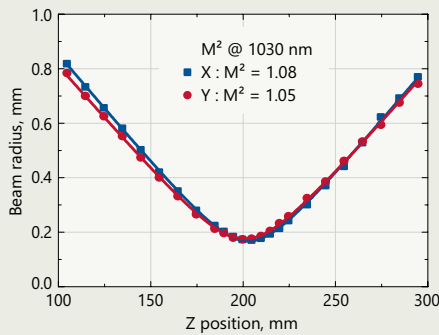

Fig 7. Typical M^2 measurement of FemtoLux 3 at 1030 nm (left) and 515 nm (right)

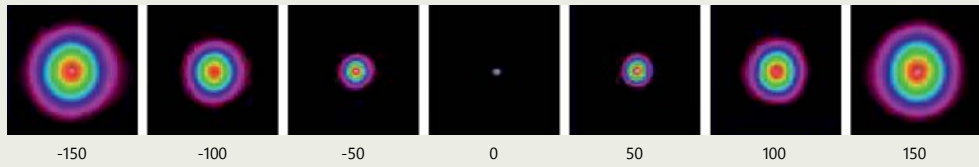

Fig 8. Typical beam profiles along propagation axis of FemtoLux 3 series laser

Remote control application

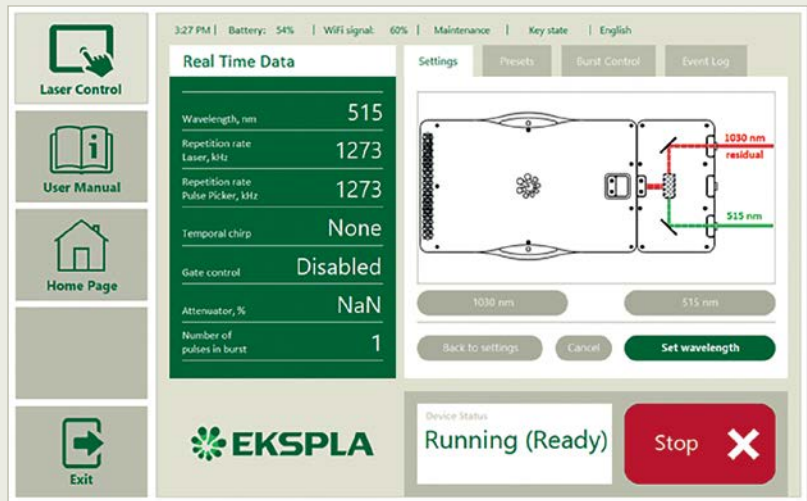

Fig 9. Example of FemtoLux 3 remote control application

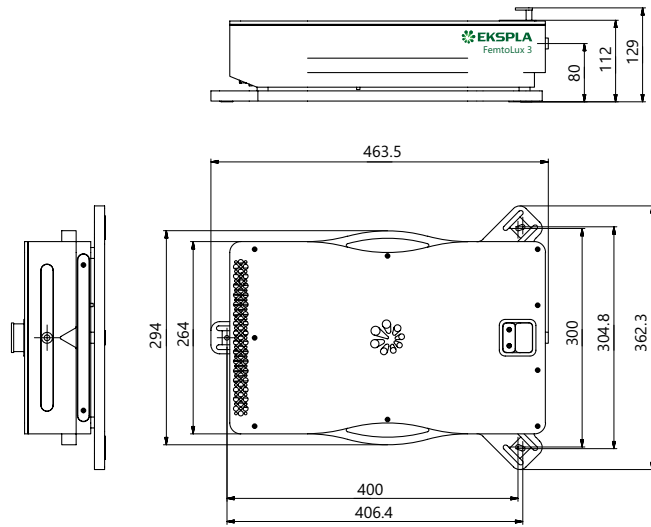

Fig 11. Outline drawings of FemtoLux 3 laser head

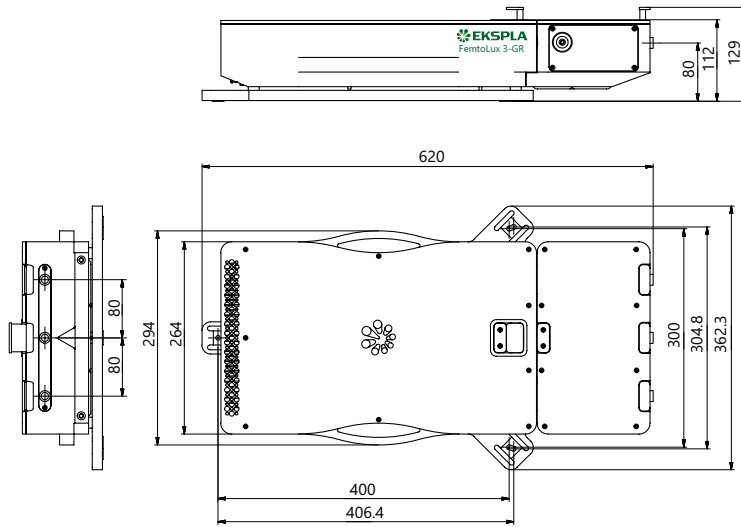

Fig 12. Outline drawings of FemtoLux 3 laser head with second harmonic option

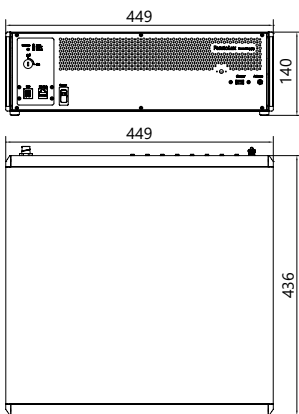

Fig 13. Outline drawings of FemtoLux 3 stand-alone control unit

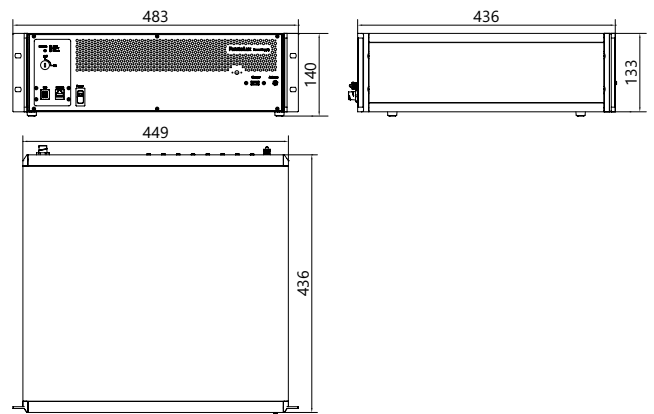

Fig 14. Outline drawings of FemtoLux 3 19" rack mountable control unit