

PGx11 SERIES

Transform Limited
Broadly Tunable
Picosecond OPA

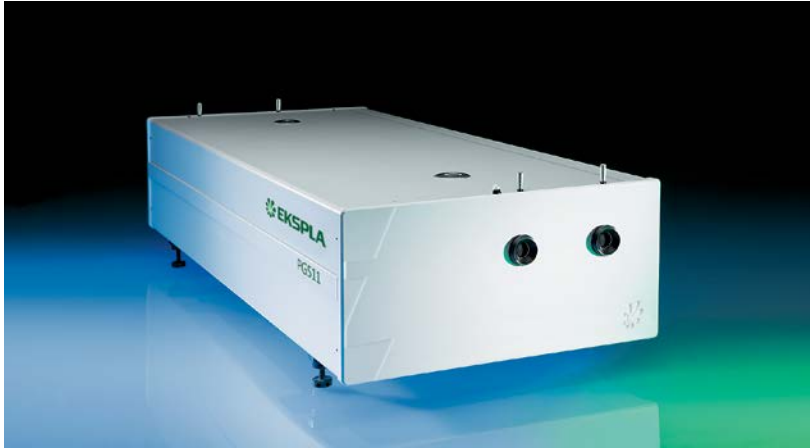

PGx11 series optical parametric devices employ advanced design concepts in order to produce broadly tunable picosecond pulses with nearly Fourier-transform limited linewidth and low divergence. High brightness output beam makes the PGx11 series units an excellent choice for advanced spectroscopy applications.

Optical layout of PGx11 units consists of Synchronously pumped Optical Parametric Oscillator (SOPO) and Optical Parametric Amplifier (OPA). SOPO is pumped by a train of pulses at approx. 87 MHz pulse repetition rate. The output from SOPO consists of a train of pulses

with excellent spatial and spectral characteristics, determined by the SOPO cavity parameters.

OPA is pumped by a single pulse temporally overlapped with SOPO output. After amplification at SOPO resonating wavelength, the PGx11 output represents a high intensity single pulse on top of a low-intensity train, while in all other spectral ranges (idler for PG411 and PG711, signal for PG511, also DFG stages) only a single high intensity pulse is present.

Three models designed for pumping by up to the 3rd harmonic of Nd:YAG laser are available.

FEATURES

- ▶ 2 cm^{-1} or 1 cm^{-1} linewidth
- ▶ High brightness picosecond pulses at 50 Hz or at up to 1 kHz pulse repetition rate
- ▶ Nearly Fourier-transform limited linewidth
- ▶ Low divergence <2 mrad
- ▶ Hands-free wavelength tuning
- ▶ Tuning range from 193 nm to 16000 nm
- ▶ PC control
- ▶ Remote control via keypad

APPLICATIONS

- ▶ Time resolved pump-probe spectroscopy
- ▶ Laser-induced fluorescence
- ▶ Infrared spectroscopy
- ▶ Nonlinear spectroscopy: vibrational-SFG, surface-SH, Z-scan, pump probe
- ▶ Other laser spectroscopy applications

Available models

Model	Features
PG411	Model has a tuning range from 410 to 2300 nm and is optimized for providing highest pulse energy in the visible part of the spectrum. When combined with an optional Second Harmonic Generator (SHG) and Sum Frequency Generator (-DUV), it offers the widest possible tuning range – from 193 to 2300 nm.
PG511	Model has a tuning range 2300–10000 nm. PG411 and PG511 models are designed to be pumped by PL2230 series lasers with a 50 Hz pulse repetition rate.
PG711	Model has 1 kHz pulse repetition rate and uses DPSS mode-locked laser of the PL2210 series for pumping. When pumped with pulses of 90 ps duration, linewidths of less than 1 cm^{-1} were measured in the spectral range up to 16 μm , which makes this device an excellent choice for time-resolved or nonlinear infrared spectroscopy.

Microprocessor based control system provides automatic positioning of relevant components, allowing hands free operation. Nonlinear crystals, diffraction grating and filters are rotated by ultra-precise stepper motors in microstepping mode, with excellent reproducibility.

Precise nonlinear crystal temperature stabilization ensures long-term stability of generated wavelength and output power.

For customer convenience the system can be controlled through USB (VCP, ASCII commands), RS232 (ASCII commands), LAN (REST API)

or RS232 (ASCII commands), LAN (REST API) depending on the system configuration or a remote control pad. Both options allow easy control of system settings.

Available standard models are summarized in a table below. Please inquire for custom-built versions.

SPECIFICATIONS ¹⁾

Model	PG411	PG411-SH	PG411-SH-DUV	PG511-DFG	PG711	PG711-DFG
Output wavelength tuning range						
SH, DUV	–	210–410 nm	193–410 nm		–	
Signal		410–709 nm		–	1550–2020 nm	
Idler		710–2300 nm		–	2250–3350 nm	
DFG		–		2300–10000 nm	–	3350–16000 nm
DFG2 (up to 16000 nm)		–		inquire	–	–
Output pulse energy ²⁾						
SH, DUV	–	100 µJ ³⁾	50 µJ ³⁾		–	
Signal		700 µJ		–	500 µJ	
Idler ⁴⁾		250 µJ		–	100 µJ	
DFG		–		> 200 µJ at 3700 nm, > 30 µJ at 10000 nm	–	20 µJ ⁵⁾
Max pulse repetition rate		50 Hz		50 Hz	1000 Hz	
Linewidth		< 3 cm ⁻¹ ⁶⁾		< 2 cm ⁻¹	< 1 cm ⁻¹	
Linewidth Idler		< 5 cm ⁻¹ ⁶⁾			–	
Typical pulse duration ⁷⁾		~20 ps		~20 ps	~70 ps	
Scanning step						
SH, DUV	–	0.01 nm			–	
Signal				0.1 nm		
Idler				1 nm		
DFG		–			1 nm	
Typical beam diameter ⁸⁾		~ 4 mm		~ 9 mm	~ 3 mm	
Beam divergence ⁹⁾		< 2 mrad				
Beam polarization ⁹⁾						
SH, DUV	–	vertical			–	
Signal		horizontal		vertical	horizontal	
Idler		vertical		horizontal	vertical	
DFG		–		horizontal	–	horizontal

¹⁾ Due to continuous improvement, all specifications are subject to change without notice. Parameters marked typical are not specifications. They are indications of typical performance and will vary with each unit we manufacture. Unless stated otherwise, all specifications are measured at 450 nm for PG411 units, 800 nm for PG511 units, and 1620 nm for PG711 units and for basic system without options.

²⁾ Pulse energies are specified at selected wavelengths. See typical tuning curves for pulse energies at other wavelengths.

³⁾ Measured at 280 nm for SH and 200 nm for DUV.

⁴⁾ Measured at 1000 nm for PG411 units, 1620 nm for PG511, and 3000 nm for PG711 units.

⁵⁾ Measured at 10000 nm.

⁶⁾ Linewidth for signal (409 – 710 nm) < 3 cm⁻¹, linewidth for idler and SH-DUV (710 – 2300 nm and 193 – 409 nm) < 5 cm⁻¹.

⁷⁾ Estimated FWHM assuming pump pulse duration 30 ps at 1064 nm for PG411 and PG511 units, and 90 ps at 1064 nm for PG711 units.

⁸⁾ Beam diameter is measured at 1/e² level and can vary depending on the pump pulse energy.

⁹⁾ Full angle measured at FWHM level.



SPECIFICATIONS ¹⁾

Model	PG411	PG411-SH	PG411-SH-DUV	PG511-DFG	PG711	PG711-DFG
PUMP LASER REQUIREMENTS						
Recommended pump source	PL2231 + APL2100-TRAIN-H411			PL2231 + H500-APL2100-TRAIN	PL2211A TR	
Min. pump energy or power ¹⁰⁾						
at 1064 nm	-		2 mJ	(10 mJ)	5 mJ at 1 kHz	
at 532 nm	-			5 mJ (8 mJ)		
at 355 nm	5 mJ (10 mJ)			-		
Pulse duration ¹¹⁾	29 ± 5 ps				90 ps	
Bream polarization at pump wavelength	vertical			horizontal		
Beam size ¹²⁾	7 mm				2.5 mm	
Beam divergence	< 0.5 mrad					
Beam profile	homogeneous, without hot spots					
PHYSICAL CHARACTERISTICS						
Size (W × L × H)	456 × 1026 × 244 mm	456 × 1226 × 244 mm		PL2231: 456 × 1026 × 244 mm H500-APL2100-TRAIN: 456 × 1026 × 244 mm		456 × 1026 × 244 mm
OPERATING REQUIREMENTS						
Room temperature	15–30 °C					
Room temperature stability	± 2 °C					
Power requirements	100–240 V single phase, 47–63 Hz					
Power consumption	< 300 W					

¹⁰⁾ The first number represents pulse train energy or power, while the value in brackets represents single pulse energy.

¹¹⁾ At FWHM level. Inquire for other available pulse duration options.

¹²⁾ Beam diameter measured at 1/e² level.

RECOMMENDED UNITS ARRANGEMENT ON OPTICAL TABLE

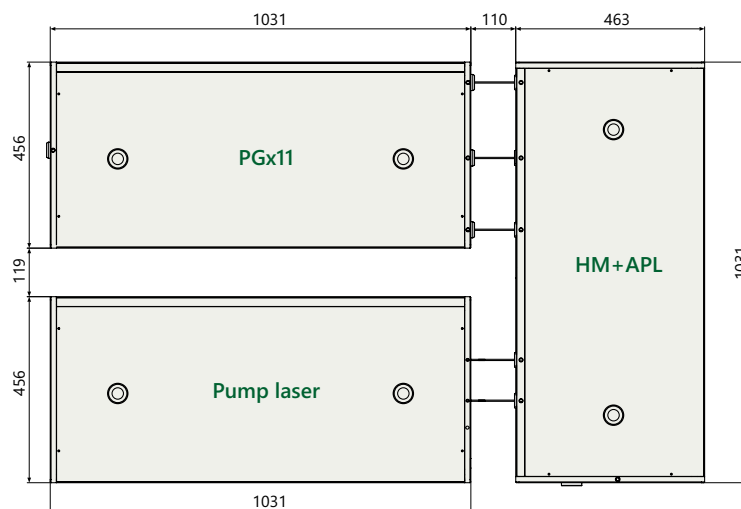

Fig 1. Arrangement of pump laser and PGx11 unit on optical table

TUNING CURVES

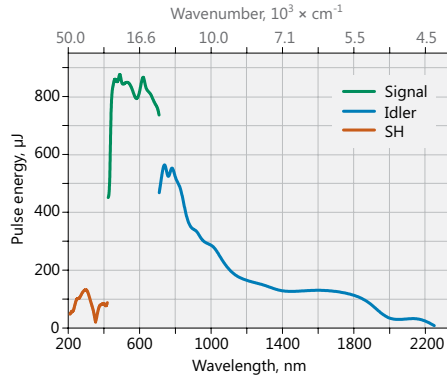

Fig 2. Typical PG411-SH model tuning curve

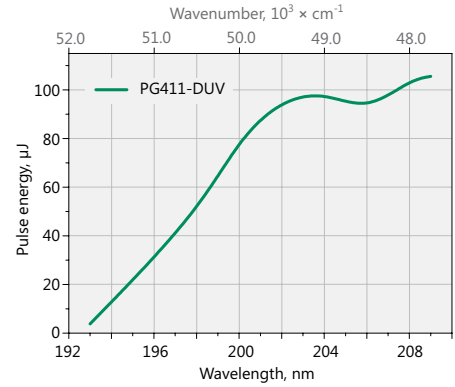

Fig 3. Typical PG411-DUV model tuning curve

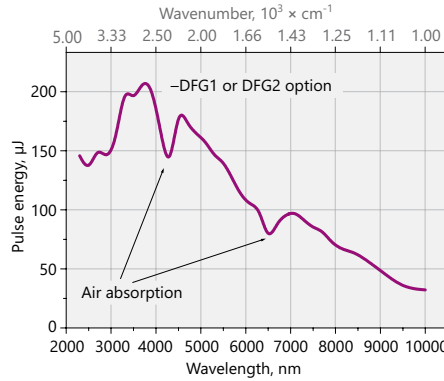

Fig 4 Typical PG511-DFG model tuning curve

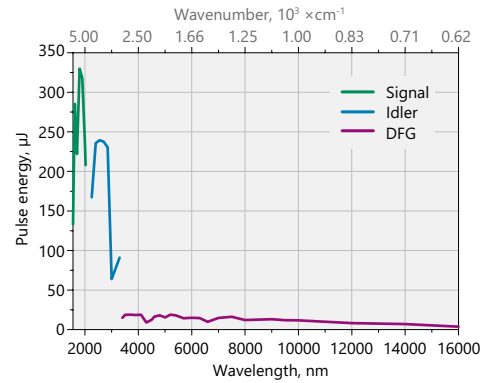

Fig 5. Typical PG711-DFG model tuning curve.

Pump energy: 2.5 mJ at 1064 nm, 1 kHz repetition rate

Note: The energy tuning curves are affected by air absorption due narrow linewidth. These pictures present pulse energies where air absorption is negligible.

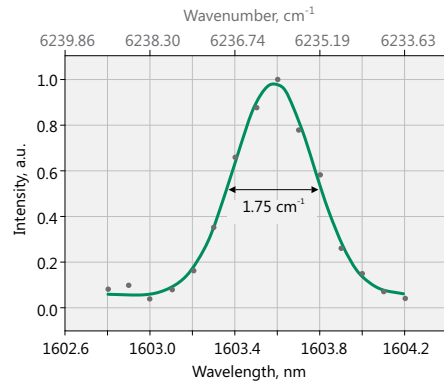

Fig 6. PG511-DFG model typical output linewidth

OUTLINE DRAWINGS

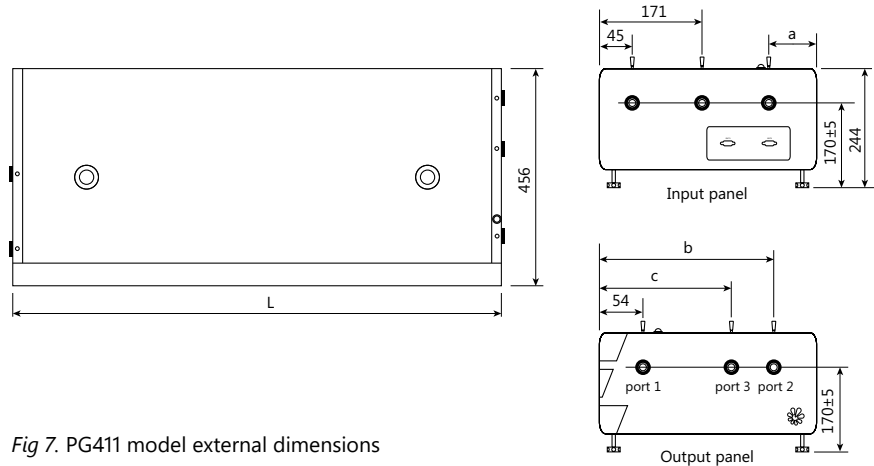

Fig 7. PG411 model external dimensions

OUTPUTS PORTS

Model	L, mm	a, mm	b, mm	c, mm	Port 1	Port 2	Port 3
PG411	1026	x	411	x	420–709 nm, 710–2300 nm	420–709 nm, 710–2300 nm	–
PG411-SH	1226	x	411	x	420–709 nm, 710–2300 nm	210–419 nm, 420–709 nm, 710–2300 nm	–
PG411-SH/DUV	1226	235	411	331	420–709 nm, 710–2300 nm	210–419 nm, 420–709 nm, 710–2300 nm	192–209.95 nm

ORDERING INFORMATION

Note: Laser must be connected to the mains electricity all the time. If there will be no mains electricity for longer than 1 hour then laser (system) needs warm up for a few hours before switching on.

PGx11-SH

Model	Optional tuning range extension
PG411 → ps 355 nm pump	SH (PG411) → 210–420 nm
PG511 → ps 532 nm pump	SH/DUV (PG411) → 193–420 nm
PG711 → ps 1064 nm pump	DFG (PG511) → 2300–10000 nm
	DFG (PG711) → 3350–16000 nm