

Laser Diode Drivers

uniLDD SERIES



Tri-uniLDD-A-QCW

uniLDD is the product line of laser diode drivers, also known as laser diode controllers, used in diode-pumped solid state lasers (DPSSL). The main purpose of laser diode drivers is to ensure precise current and temperature control of laser diodes.

Our laser diode drivers are compatible with a wide range of diodes (single emitters, bars, stacks, VCSELs, LEDs) and support both pulsed (QCW) and continuous (CW) operation modes.

Ekspla's laser diode controllers can provide currents from 10 A to 1200 A while maintaining 0.1% pk-pk current ripple and amplitude stability. Compliance voltages of our laser diode drivers vary from 1 V to 600 V.

In the vast majority of cases we either partially customize or fully tailor our laser diode drivers for an optimal performance at customer's required regimes. For high-volume OEM customers we also tailor our laser diode controllers by removing excessive components to make sure drivers are optimal parameter, cost and size wise.

Certain uniLDD laser diode driver versions can simultaneously function as current sources for laser diodes and TEC controllers, also known as Peltier element thermocontrollers. Noted laser diode driver versions can contain up to two output channels, which can be utilized as two independent TEC controllers.

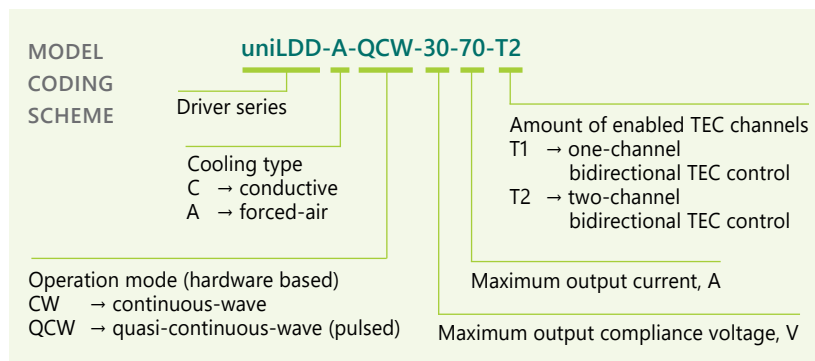



FEATURES



- ▶ Current range **from 10 A to 1200 A**
- ▶ Compliance voltage range **from 1 V to 600 V**
- ▶ Current stability of **0.1% pk to pk**
- ▶ Current ripple of **0.1% pk to pk**
- ▶ Output power up to **6 kW**
- ▶ Protections:
 - current transient (overload) protection;
 - open circuit shut-down;
 - over temperature shut-down;
 - power voltage brownout (voltage dip) shut-down;
 - interlock shut-down
- ▶ Drivers can function simultaneously as TEC controllers and LDD current sources
- ▶ Can be controlled via analog and digital (CAN, RS232) interfaces.
- ▶ Uniquely customizable modular design ensures drivers can be tailored to precisely meet OEM customer's needs
- ▶ Fast turnaround times between inquiry, prototyping and high-volume manufacturing stages

APPLICATIONS

EKSPLA laser diode drivers are optimal for pumping of femtosecond, picosecond, nanosecond and CW solid state lasers based on crystal, fiber or direct-diode technology. Most popular fields of applications are:

- ▶ Industrial lasers
micromachining, welding and cutting
- ▶ Medical lasers
ophthalmology, dermatology and surgery
- ▶ Scientific lasers
fusion research, spectroscopy, and high-energy physics

Model	uniLDD-C-CW		uniLDD-C-QCW		uniLDD-A-CW	
						
OUTPUT SPECIFICATIONS						
Operation mode	CW ¹⁾	QCW ²⁾	CW	QCW ²⁾	CW	QCW
Compliance voltage range, min-max ³⁾	1 – 70 V ⁴⁾	-	1 – 70 V	1 – 65 V	1 – 50 V	-
Current range, min-max	10 – 100 A ⁵⁾		10 – 100 A	10 – 160 A	10 – 100 A	
Power, max	3 kW ⁶⁾		3 kW	3 kW	2 kW	
Power conversion efficiency	90 – 98 %					
Current pulse amplitude stability	0.1 % pk to pk ⁷⁾					
Current ripple	0.1 % pk to pk ⁸⁾					
Current drift	< 0.2 % ⁹⁾					
Duty cycle			≤ 20 %			
Repetition rate, max			≤ 5 kHz			
Current rise time, typical	-		5 – 100 μs ¹⁰⁾		-	
Current pulse duration, typical			up to 100 ms ¹¹⁾			
RMS current, max			100 A			
Amount of functioning internal TEC control channels	0, 1 or 2 ¹²⁾					
TEC control current, min-max per channel	1 – 25 A					
TEC control voltage, min-max per channel	1 – 36 V					
TEC control power, max per channel	350 W					
INPUT SPECIFICATIONS						
Power supply requirements (power stage), min	$U_{PS\ in\ min}\ (V) = U_{LDD\ out\ max} + 5$ $P_{PS\ in\ min}\ (W) = I_{LDD\ out\ max} * U_{LDD\ out\ max} * duty\ cycle_{max} / 100\ % * 1.2$					
Power supply requirements (control stage)	12 V, 10 W				12 V, 15 W	
Control interfaces	analog, CAN & RS232 by default. USB, LAN & WLAN upon request ¹³⁾					
Software	Ekspla's control software & protocol description included by default					
Protections	current transient (overload) protection; open circuit shut-down; over temperature shut-down; power voltage brownout (voltage dip) shut-down; interlock shut-down					
PHYSICAL CHARACTERISTICS						
Dimensions (L x W x H) ¹⁴⁾	130 x 90 x 30 mm		130 x 90 x 54 mm		208 x 65 x 103 mm	
OPERATING REQUIREMENTS						
Cooling method	Conductive				Forced-air	
Operating ambient temperature	≤ 40 °C					
Operating baseplate temperature	≤ 50 °C				-	
ACCESSORIES						
CAN-USB adapter	Ekspla's CAN-USB adapter is required at evaluation stage if communication via CAN interface is needed					
Communication board	Ekspla's communication board which allows to control driver via RS232, USB, LAN, WLAN interfaces. Can be provided upon request					
Voltage booster board	Ekspla's booster board which allows to extend output compliance voltage of certain uniLDD versions. In certain cases output compliance voltage can be increased up to 600 V. Can be added at factory upon Ekspla's recommendations					
Baseplate	copper, included by default				aluminum, included upon request	
Output power cables	included upon request, custom dia and length					
Input power cables	included upon request, custom dia and length					
Control cables	included by default					
External capacitors	included upon Ekspla's recommendation. Custom mounting solutions for external capacitor are available upon request					

Model	uniLDD-A-QCW		Bi-uniLDD-A-QCW		Tri-uniLDD-A-QCW	
						
OUTPUT SPECIFICATIONS						
Operation mode	CW	QCW	CW	QCW	CW	QCW
Compliance voltage range, min-max ³⁾	1 – 50 V	1 – 85 V	1 – 50 V	1 – 85 V	1 – 50 V	1 – 85 V
Current range, min-max	10 – 100 A	10 – 360 A	20 – 200 A	20 – 800 A	30 – 300 A	30 – 1200 A
Power, max	2 kW	2 kW	4 kW	4 kW	6 kW	6 kW
Power conversion efficiency	90 – 98 %					
Current pulse amplitude stability	0.1 % pk to pk ⁷⁾					
Current ripple	0.1 % pk to pk ⁸⁾					
Current drift	< 0.2 % ⁹⁾					
Duty cycle		≤ 20 %		≤ 20 %		≤ 20 %
Repetition rate, max		≤ 5 kHz		≤ 5 kHz		≤ 5 kHz
Current rise time, typical	–	5 – 100 μs	–	5 – 100 μs	–	5 – 100 μs
Current pulse duration, typical		up to 100 ms		up to 100 ms		up to 100 ms
RMS current, max		80 A		160 A		240 A
Amount of functioning internal TEC control channels	0, 1 or 2 ¹²⁾		0			
TEC control current, min-max per channel	1 – 25 A		–			
TEC control voltage, min-max per channel	1 – 36 V		–			
TEC control power, max per channel	350 W		–			
INPUT SPECIFICATIONS						
Power supply requirements (power stage), min	$U_{PS\ in\ min}\ (V) = U_{LDD\ out\ max} + 5$ $P_{PS\ in\ min}\ (W) = I_{LDD\ out\ max} * U_{LDD\ out\ max} * duty\ cycle_{max} / 100\ % * 1.2$					
Power supply requirements (control stage)	12 V, 15 W		12 V, 20 W		12 V, 25 W	
Control interfaces	analog, CAN & RS232 by default. USB, LAN & WLAN upon request ¹³⁾					
Software	Ekspla's control software & protocol description included by default					
Protections	current transient (overload) protection; open circuit shut-down; over temperature shut-down; power voltage brownout (voltage dip) shut-down; interlock shut-down					
PHYSICAL CHARACTERISTICS						
Dimensions (L x W x H) ¹⁴⁾	208 x 65 x 103 mm		250 x 146 x 98 mm		250 x 200 x 98 mm	
OPERATING REQUIREMENTS						
Cooling method	Forced-air					
Operating ambient temperature	≤ 40 °C					
ACCESSORIES						
CAN-USB adapter	Ekspla's CAN-USB adapter is required at evaluation stage if communication via CAN interface is needed					
Communication board	Ekspla's communication board which allows to control driver via RS232, USB, LAN, WLAN interfaces. Can be provided upon request					
Voltage booster board	Ekspla's booster board which allows to extend output compliance voltage of certain uniLDD versions. In certain cases output compliance voltage can be increased up to 600 V. Can be added at factory upon Ekspla's recommendations					
Baseplate	aluminum, included upon request		aluminum, included by default			
Output power cables	included upon request, custom dia and length					
Input power cables	included upon request, custom dia and length					
Control cables	included by default					
External capacitors	included upon Ekspla's recommendation. Custom mounting solutions for external capacitor are available upon request					

- 1) Continuous-wave.
- 2) Quasi-continuous-wave (also known as pulsed).
- 3) Range between minimum and maximum limits. Not all maximal limits can be reached simultaneously.
- 4) Maximum compliance voltage can be extended for certain versions by using booster board layout. More – in section "Accessories"→"Booster board".
- 5) Maximum current can be extended for certain versions by connecting drivers in parallel.
- 6) Maximum power can be extended for certain versions by using booster board layout. More information in section "Accessories"→"Booster board".
- 7) In $\times 0.5... \times 1$ of max current range.
- 8) DC...100 kHz bandwidth, in $\times 0.5... \times 1$ of max current range.
- 9) Cold start, 8 h period, after 5 min. warm up.
- 10) Factory software tuned upon customer's request.
- 11) Factory software & hardware tuned upon customer's request.
- 12) Amount factory enabled upon customer's request.
- 13) USB ,LAN & WLAN control interfaces are available upon customer's request while using Ekspla's external communication board.
- 14) External driver dimensions can vary ± 20 mm due to the minor hardware variations like fans and current sensors.

PERFORMANCE

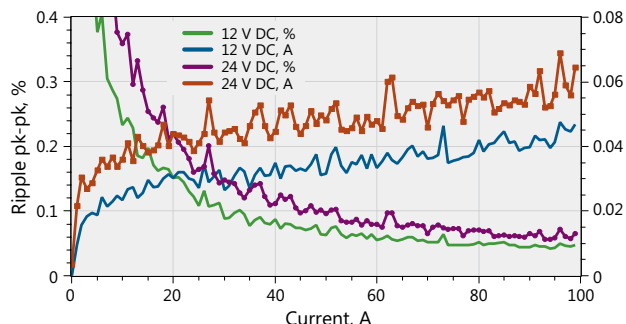

uniLDD ripple current.
12 V and 24 V DC power, 2 V junction + 10 MΩ series R load

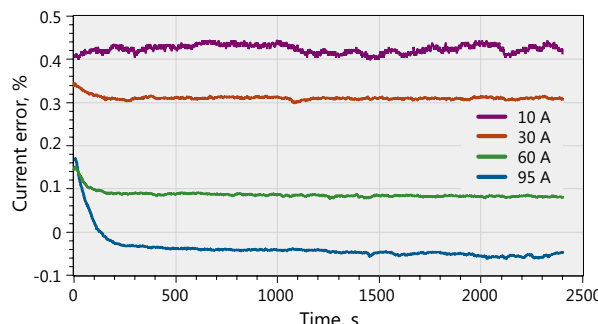

uniLDD current drift and long term stability.
From cold start for different currents

ANALOG INTERFACE PINOUT

Pin	Signal name	Direction	Voltage level	Description
1	Enable	Input	TTL (LVTTTL) 200 μA pull up to 3.3 V	The Enable function gives permission to operate for TEC driver and consequently for LDD driver.
2	Ready To Operate (RTO)	Input/Output through 330 Ω resistor	> 2.4 V driver output is active, < 0.5 V output is clamped	RTO is tied to 'High' by the driver when 'Active RTO' is enabled and the driver is in active state. Alarms clamp RTO low and disable driver output. External device may clamp RTO to GND and disable driver output. RTO allows to join fault circuits of several drivers connected in parallel
3	Interlock	Input	10 kΩ pull up to 3.3 V, LOW = < 0.4 V	The Interlock function can be connected to external safety or machine protection switches such as door or temperature switches. Open = OFF Connect to GND = RUN
4	GND			
5	V _{out} Monitor	Output	V _{out} , driver output voltage	The output voltage monitor. V _{out} = Diode compliance voltage + voltage drop on connection wires
6	I _{out} Monitor	Output	0 - 10 V* = 0 - I _{outmax}	The output current monitor
7	I _{program}	Input	0 - 10 V* = 0 - I _{outmax}	Output current setting or modulating by applying a voltage, CW and Pulse mode
8	Pulse Control	Input	TTL, LVTTTL positive pulse	In TriggerIN mode: trigger input. A rising pulse provided to this connector will trigger an output current pulse of a preset width. In Time-gated mode: input to start/stop the output current." Connection "Trigger input" performs the same function
9	GND			
10	+5V	Output	Auxiliary 200 mA	
11	+5V	Output	Auxiliary 200 mA	
12	-15V	Output	Auxiliary 100 mA	
13	+15V	Output	Auxiliary 200 mA	
14	+15V	Output	Auxiliary 200 mA	
15	GND			

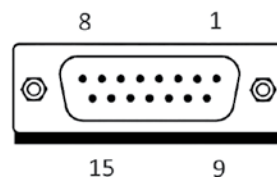

D-sub 15-pin female analog interface connector.

DRAWINGS & IMAGES

uniLDD-C-CW

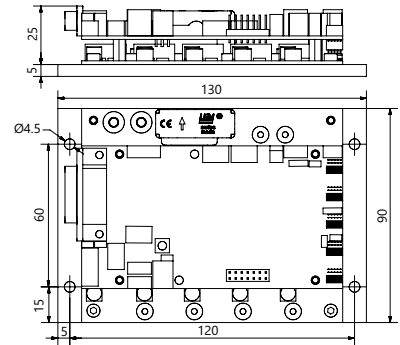
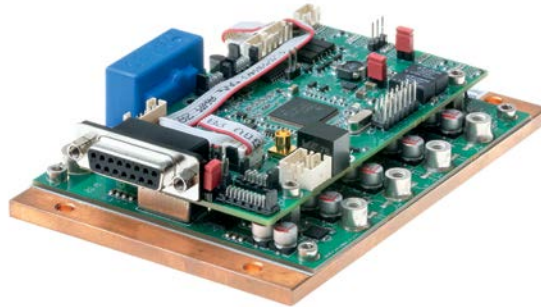

uniLDD-C-QCW

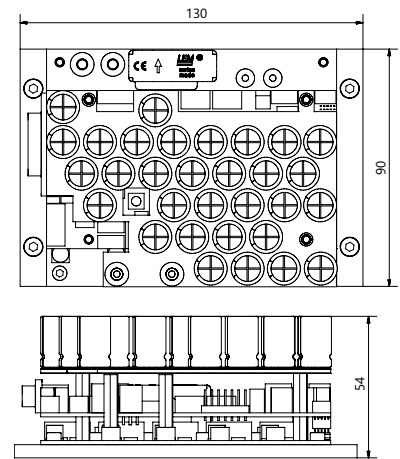
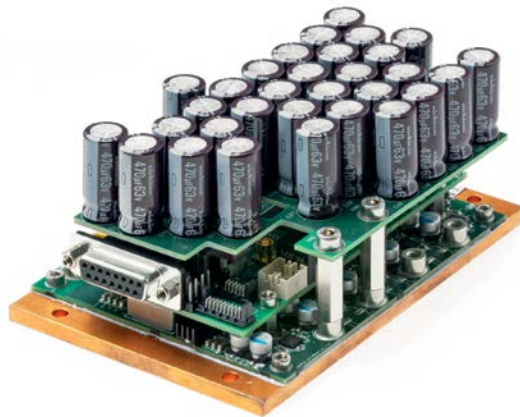

uniLDD-A-CW

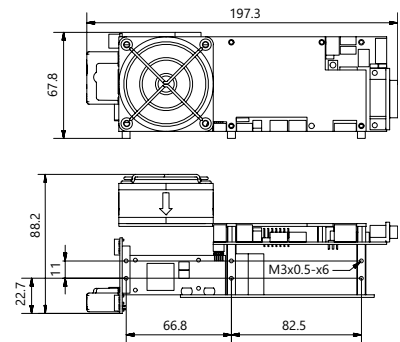

uniLDD-A-QCW

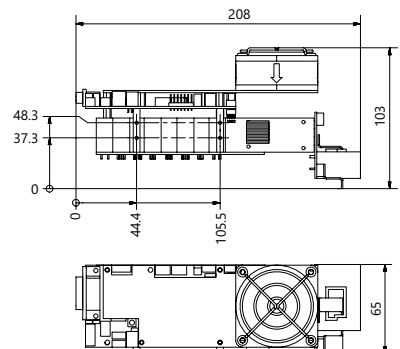
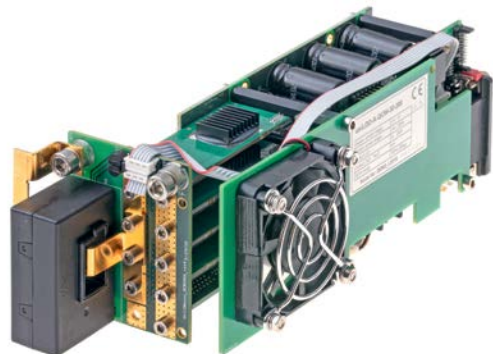

Laser diode drivers

Pockels cell drivers

Pulse and delay generators

Crystal ovens and thermocontrollers

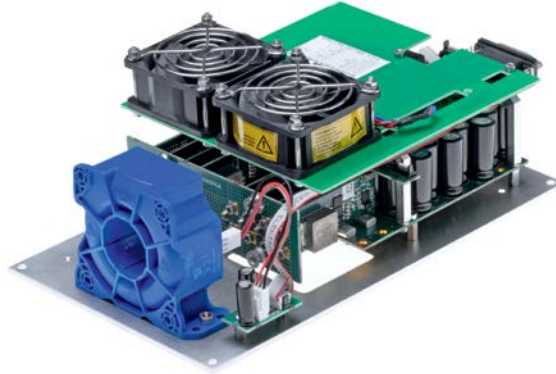

Bi-uniLDD-A-QCW

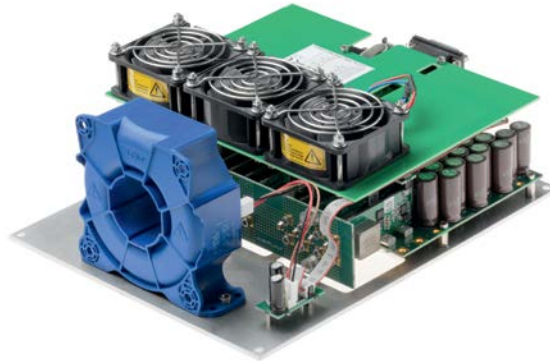
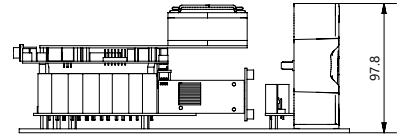
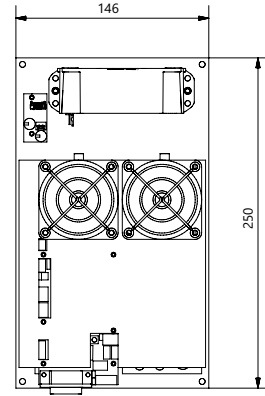

Tri-uniLDD-A-QCW

