



# Photoacoustic Imaging Sources

High output energy

Wide output wavelength range

Fast Wavelength Switching

Fiber coupling of the output beam

← Photoacoustic image of a mouse.  
*Courtesy of PhotoSound Technologies, Inc.*

2025

# Photoacoustic Imaging Sources

Photoacoustic imaging employs the physical property of molecules to briefly heat up and cool down while absorbing a short pulse of light of a certain wavelength

**Photoacoustic imaging is one of the fastest-growing research areas of non-invasive, high-resolution and high-contrast visualization of both superficial and deep tissues.**

This method has a number of advantages over widely used conventional research and diagnostic methods as unlike X-ray, it does not use hazardous irradiation and has a significantly higher imaging resolution compared to conventional ultrasound. Photoacoustic imaging is proven to be very effective in diagnosing breast tumors, skin cancer, thyroid nodules, osteoarthritis and rheumatoid arthritis, early diagnosis of blood vessel disorders and many more. Photoacoustic imaging can also be used for visualization of non-living objects, such as nondestructive inspection of the internal structure and property changes of composite materials and food inspection.

Photoacoustic imaging employs the physical property of molecules to briefly heat up and cool down while absorbing a short pulse of light (couple of nanoseconds) of a certain wavelength. While heating up, molecules expand and while cooling down, they contract. This creates an ultrasound wave which can be captured by ultrasound transducers enabling the ability to locate the origin of sound. The penetration of light into tissue depends on the tissue properties and the pulse energy of the light. Moreover, different chromophores in the tissue can absorb light of different wavelengths, thus giving functional visual information.



# Photoacoustic Imaging Sources



diode pumped



mobile



table-top

Utilizing many years of experience in the development and production of tunable wavelength, high energy lasers, EKSPLA introduced PhotoSonus series laser sources, which were designed to be used in advanced photoacoustic imaging systems. These laser sources have a wide wavelength range of 660 – 2300 nm, up to 250 mJ of pulse energy and the capability of fiber coupling of the output beam. This makes them a perfect choice for any photoacoustic imaging system for irradiating different tissues and a range of other materials.

Flash-lamp pumped PhotoSonus M laser systems combine a pump laser, OPO and power supply unit into a single mobile cart unit. Having the highest pulse energy of up to 250 mJ this is a perfect laser source for pre-clinical photoacoustic research equipment.

Diode-pumped PhotoSonus X is a low maintenance, high repetition rate (up to 100 Hz) and low noise laser system. Combining an optional internal energy meter and electromechanical shutter with laser self-test capability, this laser is certification-ready for both pre-clinical and clinical use.

A unique, fast-wavelength switching option enables each laser pulse to have a different wavelength in almost any sequence. This could be very useful while tracking changes in molecular properties within a short time period.

Flash-lamp pumped high-energy table-top PhotoSonus T series tunable wavelength laser systems can be used in research labs as a standalone OPO system as well as an irradiation source for photoacoustic imaging systems.

# Photoacoustic Imaging Sources

## SPECIFICATIONS AT A GLANCE

Not all output specifications may be available simultaneously. Please refer to the catalog page for exact specifications and available options.

Model	Available output wavelengths	Pulse duration <sup>1)</sup>	Max repetition rate	Max pulse energy	Page
<b>Diode pumped laser source</b>					
<b>PhotoSonus X</b>	650 – 1300 nm (signal) 1065 – 2600 nm (idler)	2 – 5 ns	100 Hz	90 mJ	4
<b>Mobile flashlamp pumped laser source</b>					
<b>PhotoSonus M</b>	660 – 1320 nm (signal) 330 – 659 nm (SH) 1065 – 2300 nm (idler)	3 – 5 ns	20 Hz	180 mJ	8
<b>PhotoSonus M+</b>	660 – 1064 nm (signal) <sup>2)</sup> 330 – 530 nm (SH) <sup>3)</sup> 1065 – 2300 nm (idler)	3 – 5 ns	10 Hz	250 mJ	8
<b>Table-top flashlamp pumped laser source</b>					
<b>PhotoSonus T</b>	660 – 1320 nm (signal) 330 – 659 nm (SH) 1065 – 2300 nm (idler)	3 – 5 ns	20 Hz	150 mJ	12
<b>PhotoSonus T+</b>	660 – 1064 nm (signal) <sup>2)</sup> 330 – 530 nm (SH) <sup>3)</sup> 1065 – 2300 nm (idler)	3 – 5 ns	10 Hz	230 mJ	12

<sup>1)</sup> FWHM measured with photodiode featuring 1 ns rise time and 300 MHz bandwidth oscilloscope.  
<sup>2)</sup> Optional signal extended range: 660 – 1320 nm.  
<sup>3)</sup> When extended signal range is selected, wavelength range is 330 – 659 nm.

Due to the constant product improvements, EKSPLA reserves its right to change specifications without advance notice.



Latest information  
about Industrial Lasers  
[www.ekspla.com](http://www.ekspla.com)

ns

Photoacoustic  
Imaging  
Sources

# PhotoSonus X



See list of publications  
written by employing  
**PhotoSonus** series lasers



CLASS 4 LASER PRODUCT  
NS-20001-2016

YAG LASER	PARAMETRIC GENERATION
MAX OUTPUT: 500 mJ	MAX OUTPUT: 100 mJ
PULSE DURATION: 2.5 ns	PULSE DURATION: 2.5 ns
WAVELENGTH: 1064, 532 nm	WAVELENGTH: 488, 1060 nm

**AVOID EYES** **BE SURE**  
VISIBLE LASER RADIATION  
EMITTED FROM  
THIS LASER SYSTEM  
BE SURE

 **EKSPLA** PhotoSonus X

FIRE W/LOCK SHUTTER

# High Output Power DPSS Tunable Laser for Photoacoustic Imaging

## PhotoSonus X

**PhotoSonus X is a perfect solution for photoacoustic imaging in pre-clinical and clinical use and when fast sample scanning is required.**

Having high output energy of up to 90 mJ at the peak, a broad wavelength tuning range from 650 to 2600 nm, high pulse repetition rate up to 100 Hz and fast wavelength switching makes it a perfect photoacoustic imaging source for gaining high-resolution images and ensuring high data acquisition rate. Moreover, being built on a diode pumped solid-state laser platform, PhotoSonus X assures significantly quieter operation (< 60 dB) compared with flash-lamp pumped lasers, which is very beneficial for clinical use.

Diode pumped laser technology and well-engineered system design ensures high reliability and low-cost system operation. PhotoSonus X output can be coupled with almost any type of fiber bundle.

With additional options of an internal energy meter and electromechanical shutter with laser self-test capability, PhotoSonus X can be ready for certification in clinical photoacoustic applications.

## Features

Ultra-wide signal tuning range from **650 to 1300 nm**

Fully motorized wavelength tuning

Fast wavelength switching

Externally triggerable

High, up to **90 mJ** pulse energy from OPO

**100 Hz** or **50 Hz** pulse repetition rate

Certification ready

Quiet operation < **60 dB**

Integrated DPSS pump laser and OPO into a single housing

Fiber bundle or fiber

Signal and idler through the same output (optional)

Integrated energy meter (optional)

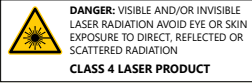
Electromechanical output shutter with laser self-test capability

650 –  
1300 nm / 90 mJ / < 60 dB

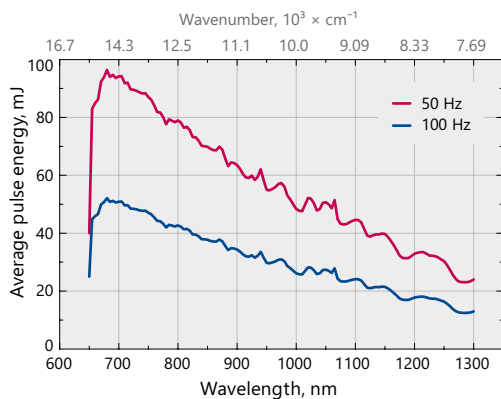


Learn more  
about PhotoSonus X  
[www.ekspla.com](http://www.ekspla.com)

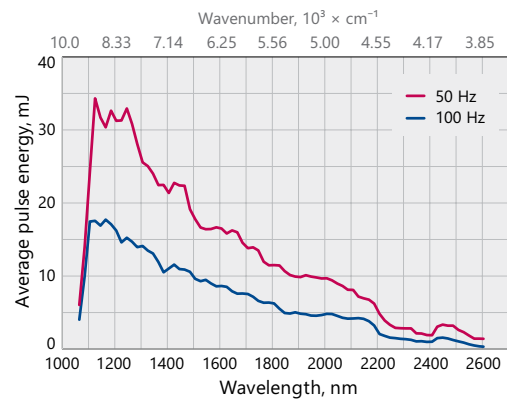
## Specifications <sup>1)</sup>

Model	PhotoSonus X-50	PhotoSonus X-100
<b>OPO</b>		
Wavelength range	Signal	650 – 1300 nm
	Idler (optional)	1065 – 2600 nm
OPO output max pulse energy <sup>2)</sup>	> 90 mJ	> 50 mJ
Pulse repetition rate <sup>3)</sup>	50 Hz	100 Hz
Scanning step	Signal	0.1 nm
	Idler	1 nm
Pulse duration <sup>4)</sup>	2 – 5 ns	
Signal linewidth <sup>5)</sup>	< 15 cm <sup>-1</sup>	< 10 cm <sup>-1</sup>
Typical signal beam diameter (1/e <sup>2</sup> ) <sup>6)</sup>	6 ± 1 mm	
Control interfaces	LAN, RS232	
<b>Physical characteristics</b>		
Cooling	Closed loop air-water cooled <sup>7)</sup>	
Unit size (W × L × H)	551 × 400 × 162 mm	
Power supply size (W × L × H)	483 × 390 × 140 mm	
Umbilical length	0.5 m	
<b>Operating requirements</b>		
Room temperature	18 – 27 °C	
Relative humidity	20 – 80 % (non-condensing)	
Power requirements	100 – 240 VAC, single phase 50/60 Hz	
Power consumption	< 2 kW	
<p><sup>1)</sup> Due to continuous improvement, all specifications are subject to change without notice. The parameters marked typical are not specifications. They are indications of typical performance and will vary with each unit we manufacture. Unless stated otherwise all specifications are measured at 700 nm.</p> <p><sup>2)</sup> Measured at the free space output. See tuning curves for typical energy levels at different wavelengths.</p> <p><sup>3)</sup> Other fixed pulse repetition rates are available upon request.</p> <p><sup>4)</sup> FWHM measured with photodiode featuring 1 ns rise time and 300 MHz bandwidth oscilloscope.</p> <p><sup>5)</sup> At 700 nm or higher wavelength.</p> <p><sup>6)</sup> Measured at the free space output at 700 nm wavelength.</p> <p><sup>7)</sup> Using external chiller.</p>		
		

## Performance

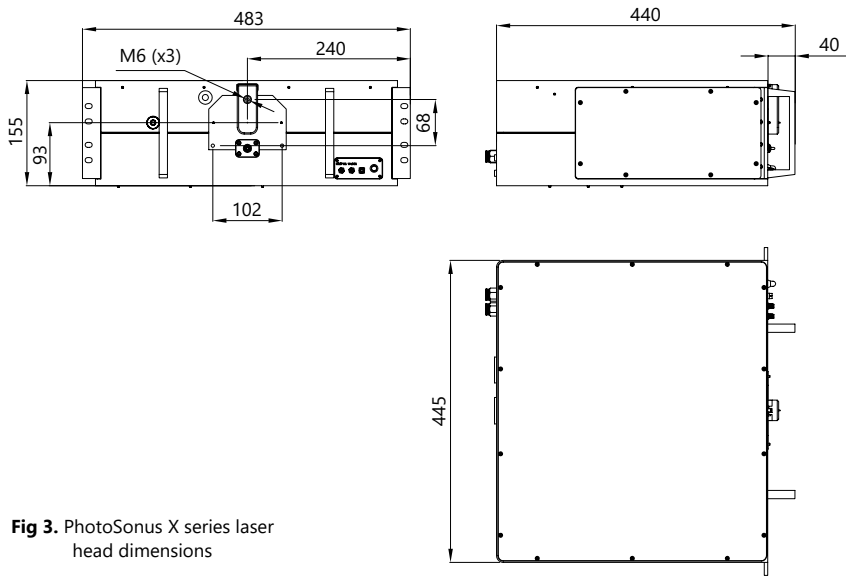


**Fig 1.** Typical PhotoSonus X free space extended range signal output energy vs. wavelength

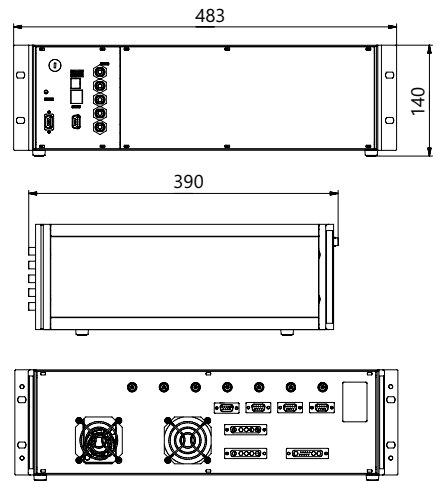


**Fig 2.** Typical PhotoSonus X free space idler output energy vs. wavelength

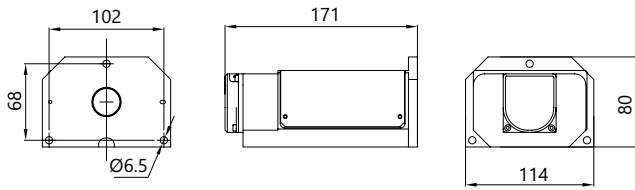
# Drawings



**Fig 3.** PhotoSonus X series laser head dimensions



**Fig 4.** Outline drawing of PhotoSonus X power supply unit



**Fig 5.** Outline drawing and dimensions of 3 mm fiber bundle



**Fig 6.** PhotoSonus X laser head with power supply units and cooling chiller installed in one rack

# Ordering information

**Note:** Laser must be connected to the mains electricity all the time. If there will be no mains electricity for longer than 1 hour then laser (system) needs warm up for a few hours before switching on.

PhotoSonus X-50-IDL-EM-EFBC	
Model	EFBC → exchangeable fiber coupling module
X → diode-pumped version	EM → OPO energy meter
Repetition rate: 50 → 50 Hz 100 → 100 Hz	IDL → idler option



ns

Photoacoustic  
Imaging  
Sources

# PhotoSonus M



See list of publications  
written by employing  
**PhotoSonus** series lasers



# High Energy, Mobile, Tunable Wavelength Laser Source for Photoacoustic Imaging

## PhotoSonus M

**Following the demand for high output energies in the photoacoustic market for imaging larger volumes of tissue, PhotoSonus M, an updated high energy tunable laser source for photo-acoustic imaging, was introduced.**

Time-tested Ekspla nanosecond pump laser, parametric oscillator, power supply and cooling unit are integrated in a single robust housing to provide mobility, ease of use and low maintenance cost. The highly flexible PhotoSonus M platform makes it easily integrated and used in a photoacoustic imaging system. It is fully motorized and computer controlled, with user trigger outputs and inputs and special options such as motorized switching between OPO signal and idler, motorized attenuator, internal energy meter and electromechanical output shutter.

Recently, a fast wavelength switching option was introduced that enables each laser pulse to have a different wavelength within the entire signal or idler range and at any sequence. This new feature, combining high pulse energy (up to 180 mJ) and wide wavelength tuning range (330 – 2300 nm) makes PhotoSonus M the irreplaceable imaging source for any photo acoustic system.

For even higher sample imaging depth and resolution a PhotoSonus M+, with up to 250 mJ maximum pulse energy, was introduced.

For convenience, the outputs of PhotoSonus M and PhotoSonus M+ lasers can be coupled with almost any type of fiber bundle.

## Features

High up to **250 mJ** output energy

Wide tuning range from **330 to 2300 nm**

Ultra-wide OPO signal tuning range from **660 to 1320 nm**

**10 Hz** or **20 Hz** pulse repetition rate

Integrated pump laser, OPO and PSU in single mobile unit

Low maintenance cost

Fiber bundle connectors with safety interlock

Fast wavelength switching within entire signal or idler range between two consecutive pulses

Integrated energy meter (optional)

Motorized attenuator (optional)

Access to pump laser wavelengths 1064/532 nm (optional)

330 –  
2300 nm

250 mJ

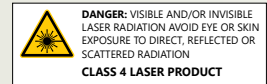
10 Hz  
20 Hz



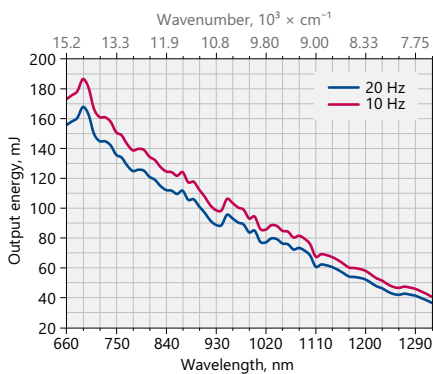
Learn more  
about PhotoSonus M  
[www.ekspla.com](http://www.ekspla.com)

## Specifications <sup>1)</sup>

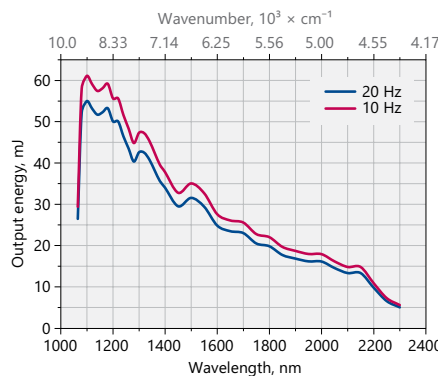
Model	PhotoSonus M-10	PhotoSonus M-20	PhotoSonus M+
<b>OPO</b>			
Wavelength range	Signal	660 – 1320 nm	660 – 1064 nm <sup>2)</sup>
	SH extension range (optional)	330 – 659 nm	330 – 530 nm (330 – 659 nm <sup>3)</sup> )
	Idler (optional)		1065 – 2300 nm
OPO output MAX pulse energy <sup>4)</sup>	> 180 mJ	> 160 mJ	> 250 mJ
Pulse repetition rate	10 Hz	20 Hz	10 Hz
Scanning step	Signal	0.1 nm	
	Idler	1 nm	
Pulse duration <sup>5)</sup>		3 – 5 ns	
Signal linewidth <sup>6)</sup>		< 10 cm <sup>-1</sup>	
Typical signal beam diameter (1/e <sup>2</sup> ) <sup>7)</sup>		7 ± 2 mm	9 ± 2 mm
<b>Physical characteristics</b>			
Unit size (W × L × H mm)	434 × 672 × 887 mm		
<b>Operating requirements</b>			
Room temperature	18 – 27 °C		
Relative humidity	20 – 80 % (non-condensing)		
Power requirements <sup>8)</sup>	208 or 240 VAC, single phase 50/60 Hz		
Power consumption	< 1.0 kVA	< 1.5 kVA	< 1.5 kVA
<p><sup>1)</sup> Due to continuous improvement, all specifications are subject to change without notice. The parameters marked typical are not specifications. They are indications of typical performance and will vary with each unit we manufacture. Unless stated otherwise all specifications are measured at 700 nm.</p> <p><sup>2)</sup> Optional signal extended range: 660 – 1320 nm.</p> <p><sup>3)</sup> When extended signal range is selected.</p> <p><sup>4)</sup> Measured at the free space output. See tuning curves for typical energy levels at different wavelengths.</p> <p><sup>5)</sup> FWHM measured with photodiode featuring 1 ns rise time and 300 MHz bandwidth oscilloscope.</p> <p><sup>6)</sup> At 700 nm or higher wavelengths.</p> <p><sup>7)</sup> Measured at the free space output at 700 nm. Can be adjusted as per request.</p> <p><sup>8)</sup> Mains voltage should be specified when ordering.</p>			



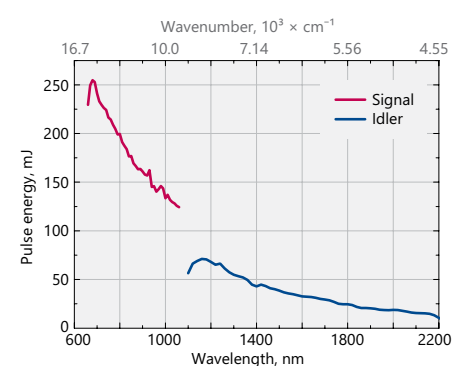
## Performance



**Fig 1.** Typical PhotoSonus M-10 and M-20 Extended signal output pulse energy vs. wavelength curve

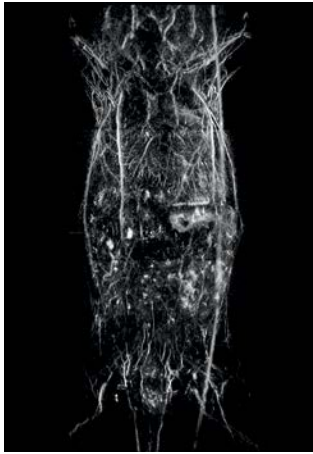


**Fig 2.** Typical PhotoSonus M-10 and M-20 Idler output pulse energy vs. wavelength curve



**Fig 3.** Typical PhotoSonus M+ signal and idler output pulse energy vs. wavelength curve

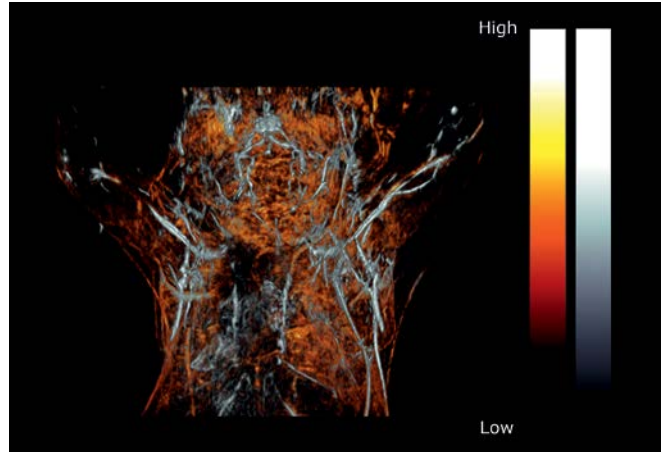
# Sample Photoacoustic Images



Photoacoustic image of a mouse.



Photoacoustic image of the mouse liver.



Photoacoustic image of the upper torso and brain of a female mouse.

Courtesy of PhotoSound Technologies, Inc.

## Drawings

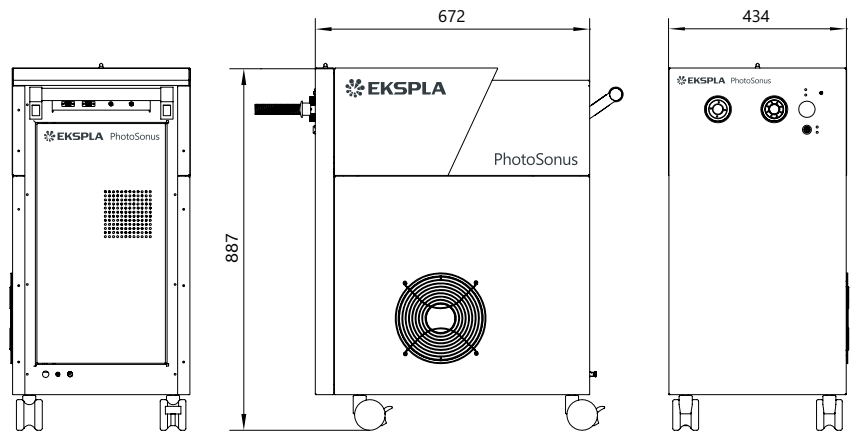


Fig 4. PhotoSonus M outline drawings (mm)

## Ordering information

**Note:** Laser must be connected to the mains electricity all the time. If there will be no mains electricity for longer than 1 hour then laser (system) needs warm up for a few hours before switching on.

### PhotoSonus M-10-IDL-SH-ATTN-H-EM-PD

Model

M → Mobile version  
 M+ → Mobile highest energy version (10 Hz only)

Repetition rate:  
 10 → 10 Hz  
 20 → 20 Hz

IDL → idler option

OPO extension:  
 SH → OPO SH extension range  
 ER → extended OPO signal range (for M+ model only)

PD → footswitch laser emission control

EM → OPO energy meter

H → 1064 nm pump wavelength output  
 2H → 532 nm pump wavelength output

ATTN → OPO attenuator

# PhotoSonus T

## BENEFITS

High pulse energy (up to 230 mJ) is highly beneficial for photoacoustics imaging applications

Superior tuning resolution ( $1 - 2 \text{ cm}^{-1}$ ) allows recording of high quality spectra

High integration level saves space in the laboratory

Flashlamps replacement without misalignment of the laser cavity saves on maintenance costs

In-house design and manufacturing of complete systems, including pump lasers, guarantees on-time warranty and post warranty services and spares supply

Variety of control interfaces: USB, RS232, optional LAN and WLAN ensures easy control and integration with other equipment

Attenuator and fiber bundle coupling options facilitate incorporation of PhotoSonus T systems into various experimental environments



# High Energy Table-Top Tunable Wavelength Lasers for Photoacoustic Imaging

## PhotoSonus T

**PhotoSonus T series tunable laser seamlessly integrates in a compact housing a nanosecond optical parametric oscillator and Nd:YAG Q-switched laser.**

Three models with different output pulse energy values and different repetition rates are offered. The most powerful model has more than 230 mJ pulse energy. Narrow linewidth ( $<10 \text{ cm}^{-1}$ ) is nearly constant through almost whole tuning range, which makes laser suitable for many spectroscopy application.

The device is controlled from the remote keypad or PC using LabVIEW™ drivers that are supplied with the system. The remote pad features a backlit display that is easy to read even while wearing laser safety glasses.

System is designed for easy and cost-effective maintenance. Replacement of flashlamps can be done without misalignment of the laser cavity and deterioration of laser performance. OPO pump energy monitoring system helps to increase lifetime of the optical components.

## Options

Optional items are available allowing optimization of the laser system for Your application, for example:

- / Fiber bundle coupled output;
- / Energy meter;
- / Efficient second harmonic generator for 330–660 nm range;
- / Pulse energy attenuator;
- / Water-air cooled power supply.

Please inquire custom-build versions and options.

## Features

Hands-free, automated wavelength tuning from **330 to 2600 nm**

Ultra-wide OPO signal tuning range from **660 to 1320 nm**

Up to **230 mJ** in range 660 – 2600 nm, **35 mJ** in range 330 – 660 nm

Narrow linewidth across tuning range

**3–5 ns** pulse duration

Remote control via key pad or PC

Separate output port for 532 nm beam. Output for 1064 nm is optional

OPO pump energy monitoring

Fast wavelength switching within entire signal or idler ranges

## Applications

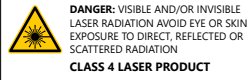
- / Photoacoustic imaging
- / Flash photolysis
- / Photobiology
- / Remote sensing
- / Non-linear spectroscopy

330 – 2600 nm / 230 mJ / 3 – 5 ns

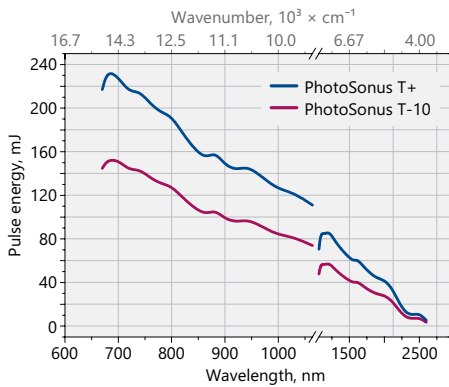


Learn more  
about PhotoSonus T  
[www.ekspla.com](http://www.ekspla.com)

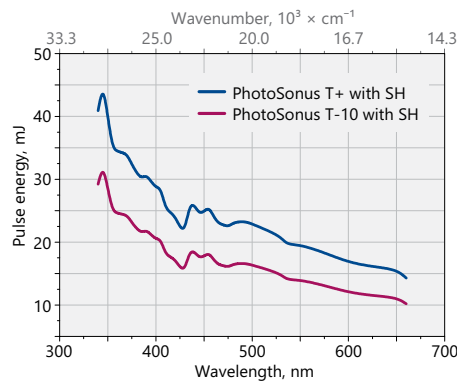
## Specifications <sup>1)</sup>

Model		PhotoSonus T-10	PhotoSonus T-20	PhotoSonus T+
<b>OPO</b>				
Wavelength range	Signal	660–1320 nm	660–1320 nm	660–1064 nm <sup>2)</sup>
	Idler	1065–2600 nm	1065–2600 nm	1065–2600 nm
	SH (optional)	330–660 nm	330–660 nm	330 – 530 nm (330 – 659 nm) <sup>3)</sup>
Output max pulse energy <sup>4)</sup>	OPO	150 mJ	130 mJ	230 mJ
	SH	25 mJ	21 mJ	35 mJ
Linewidth <sup>5)</sup>		< 10 cm <sup>-1</sup>	< 10 cm <sup>-1</sup>	< 20 cm <sup>-1</sup>
Tuning resolution <sup>6)</sup>	Signal		1 cm <sup>-1</sup>	
	Idler		1 cm <sup>-1</sup>	
	SH		2 cm <sup>-1</sup>	
Pulse duration <sup>7)</sup>			3–5 ns	
Typical beam diameter <sup>8)</sup>		7 mm	7 mm	9 mm
Typical beam divergence <sup>9)</sup>			<2 mrad	
Polarization	Signal beam		horizontal	
	Idler beam		vertical	
	SH beam		vertical	
<b>Pump laser <sup>10)</sup></b>				
Pump wavelength			532 nm	
Pulse duration			4 – 6 ns	
Beam quality		"Hat-Top" in near field. Close to Gaussian in far field		
Beam divergence			<0.6 mrad	
Pulse energy stability (StdDev)			<2.5 %	
Pulse repetition rate		10 Hz	20 Hz	10 Hz
<b>Physical characteristics</b>				
Unit size (W × L × H)			456 × 821 × 270 mm	
Power supply size (W × L × H)			330 × 490 × 585 mm	
Umbilical length			2.5 m	
<b>Operating requirements</b>				
Water consumption (max 20 °C) <sup>11)</sup>			<10 l/min	
Room temperature			18–27 °C	
Relative humidity			20–80 % (non-condensing)	
Power requirements <sup>12)</sup>			200 – 240 VAC, single phase, 50/60 Hz	
Power consumption			< 1.5 kW	
Cleanliness of the room			not worse than ISO Class 9	
<p><sup>1)</sup> Due to continuous improvement, all specifications are subject to change without notice. The parameters marked typical are not specifications. They are indications of typical performance and will vary with each unit we manufacture. Unless stated otherwise all specifications are measured at 700 nm and for basic system without options.</p> <p><sup>2)</sup> Optional signal extended range: 660 – 1320 nm.</p> <p><sup>3)</sup> When extended signal range is selected.</p> <p><sup>4)</sup> See tuning curves for typical outputs at different wavelengths.</p> <p><sup>5)</sup> At 700 nm or higher wavelengths.</p> <p><sup>6)</sup> When wavelength is controlled from PC. When wavelength is controlled from keypad, tuning resolution is 0.1 nm for signal, 1 nm for idler and 0.5 nm for SH.</p>		<p><sup>7)</sup> FWHM measured with photodiode featuring 1 ns rise time and 300 MHz bandwidth oscilloscope.</p> <p><sup>8)</sup> Beam diameter is measured at 700 nm at the 1/e<sup>2</sup> level and can vary depending on the pump pulse energy.</p> <p><sup>9)</sup> Full angle measured at the FWHM level at 700 nm.</p> <p><sup>10)</sup> Separate output port for the 532 nm beam is standard. Output for 1064 nm beam is optional. Pump laser output will be optimized for the best OPO operation and specification may vary with each unit we manufacture.</p> <p><sup>11)</sup> Air cooled power supply is available as option.</p> <p><sup>12)</sup> Mains voltage should be specified when ordering.</p>		

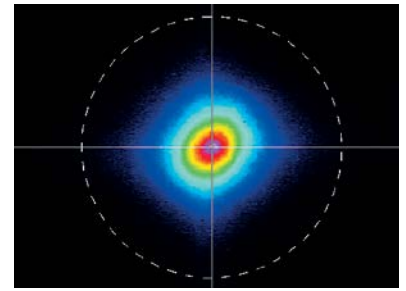
## Performance



**Fig 1.** Typical output energy of the PhotoSonus T tunable wavelength systems



**Fig 2.** Typical output energy of the PhotoSonus T tunable wavelength systems with SH option



**Fig 3.** Typical far field beam profile of PhotoSonus T laser at 800 nm

## Ordering information

**Note:** Laser must be connected to the mains electricity all the time. If there will be no mains electricity for longer than 1 hour then laser (system) needs warm up for a few hours before switching on.

PhotoSonus T-10-SH-FBC-ATTN-H-EM-AW10-TrigBox-110VAC	
Model	110VAC → transformer for 110 V AC mains
T → Table-top version	
T+ → Table-top highest energy version (10 Hz only)	TrigBox → synchronization box
Repetition rate:	Water-air cooling unit:
10 → 10 Hz	AW10 → for 10 Hz models
20 → 20 Hz	AW20 → for 20 Hz models
OPO extension:	EM → OPO energy meter
SH → OPO SH extension range	
ER → extended OPO signal range (for T+ model only)	H → additional output for 1064 nm pump wavelength
FBC → fiber or fiber bundle coupling of OPO output without attenuator	ATTN → OPO attenuator
	ATTN/FBC → OPO attenuator for FBC output
	ATTN/FBC/FS → OPO attenuator for both FBC and free space outputs



# Ordering Information

<b>Delivery</b>	Products are made and dispatched within agreed term. Shipping charges are object of agreement between EKSPLA and customer.
<b>Ordering</b>	Orders may be placed by mail, fax or e-mail. All orders are object of General Sales Conditions, which can be found on <a href="http://www.ekspla.com">www.ekspla.com</a> . Mail orders should be sent to: EKSPLA, UAB Savanoriu Av. 237 LT-02300 Vilnius Lithuania Phone: +370 5 264 96 29 Fax: +370 5 264 18 09 E-mail: <a href="mailto:sales@ekspla.com">sales@ekspla.com</a> <b>Ask for quotation online at <a href="http://www.ekspla.com">www.ekspla.com</a>.</b>
<b>Certificate of Origin</b>	All items shown in this catalogue are of Lithuanian Origin (EU). Certificate of Origin is available under request.
<b>Warranty</b>	All products are guaranteed to be free from defects in material and workmanship. The warranty period depends on the product and is object of agreement between EKSPLA and customer. Warranty period can be extended by separate agreement. EKSPLA does not assume liability for improper installation, labour or consequential damages.
<b>Specifications</b>	Due to the constant product improvements, EKSPLA reserves its right to change specifications without advance notice.


For latest information visit [www.ekspla.com](http://www.ekspla.com).



ISO9001 Certified

Find local distributor at  
[www.ekspla.com](http://www.ekspla.com)



Follow us on Linked 

Savanorių Av. 237  
LT-02300 Vilnius  
Lithuania

ph. +370 5 264 96 29  
fax +370 5 264 18 09  
[sales@ekspla.com](mailto:sales@ekspla.com)  
[www.ekspla.com](http://www.ekspla.com)